



WORTH FIELD
ENTERPRISES



Surgical

CATALOGUE

www.wfent.biz



TABLE OF CONTENTS



CLASS NAME	PAGE NO.
GENERAL INSTRUMENTS	01
DIAGNOSTICS	08
VACCINATION AND PUNCTURE	11
SCISSORS	19
FORCEPS	47
ARTERY FORCEPS AND CLAMPS	60
SUTURE	94
SUPERCUT SCISSORS AND T/C GOLD PLATED	106
DRESSING	137
ORTHOPEDIC INSTRUMENTS	142
BONE SURGERY	146
ASEPSIS	210
RETRACTORS	213
RHINOLOGY	261
CARDIOVASCULAR	292
INTESTINE STOMACH RECTUM	327
LIVER, GALL BLADDER, KIDNEY	340
RECTAL AND GENTO-URINARY	348
TRACHEOTOMY	351
GYNECOLOGY	352
NEURO-SURGERY	383
OTOLOGY	407
ORAL AND FACIAL SURGERY	426
TONSILS AND LARYNGO INSTRUMENTS	438
ANAESTHESIA	445
ENDOSCOPIC INSTRUMENTS	447
MICRO SURGERY	464
OPTHELMIC SURGERY	470



General Instruments Scalpel Handles



#3
WFE-080-001



#4
WFE-080-002



#7
WFE-080-003



#3L
WFE-080-004



#4L
WFE 080-005



General Instruments Scalpel Handles



1/1

Standard
WFE-002-006
No. 3
Solid



1/1

WFE-002-008
No. 3
Solid



1/1

WFE-002-007
No. 3
Solid



1/1

WFE-002-008
No. 3L
Solid Straight

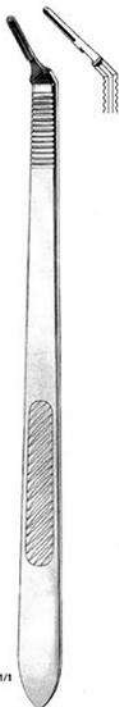

1/1

WFE-020-005
No. 3L
Solid Angled





WFE-003-001 11.5 cm / 4 1/2"
 WFE-003-002 13.0 cm / 5"
 WFE-003-003 14.0 cm / 5 1/2"
 WFE-003-004 16.0 cm / 6 1/4"
 WFE-003-005 18.0 cm / 7"
 WFE-003-006 20.0 cm / 8"
 WFE-003-007 25.0 cm / 10"

2 mm ø



WFE-003-008 11.5 cm / 4 1/2"
 WFE-003-009 13.0 cm / 5"
 WFE-003-010 14.0 cm / 5 1/2"
 WFE-003-011 16.0 cm / 6 1/4"
 WFE-003-012 18.0 cm / 7"
 WFE-003-013 20.0 cm / 8"

1 mm ø



WFE-003-014 14.0 cm / 5 1/2"
 WFE-003-015 18.0 cm / 6 1/4"

2 mm ø



WFE-003-016 14.0 cm / 5 1/2"
 WFE-003-017 18.0 cm / 6 1/4"

2 mm ø



WFE-003-018 13.0 cm / 5"
 WFE-003-019 14.0 cm / 5 1/2"
 WFE-003-020 16.0 cm / 6 1/4"
 WFE-003-021 18.0 cm / 7"
 WFE-003-022 20.0 cm / 8"
 WFE-003-023 25.0 cm / 10"

2 mm ø



WFE-003-024 14.0 cm / 5 1/2"
 WFE-003-025 18.0 cm / 7"

2 mm ø





Stacke
WFE-004-026
10.5 cm / 4 1/8"
1 mm Ø



WFE-004-027 14.0 cm / 5 1/2"
WFE-004-028 16.0 cm / 6 1/4"
WFE-004-029 20.0 cm / 8"



WFE-004-030 11.5 cm / 4 1/2"
WFE-004-031 13.0 cm / 5"
WFE-004-032 14.0 cm / 5 1/2"
WFE-004-033 16.0 cm / 6 1/4"
WFE-004-034 18.0 cm / 7"
WFE-004-035 20.0 cm / 8"



WFE-004-036 13.0 cm / 5"
WFE-004-037 14.0 cm / 5 1/2"
WFE-004-038 16.0 cm / 6 1/4"
WFE-004-039 18.0 cm / 7"



Doyen
WFE-004-036
14.0 cm / 5 1/2"



Nelaton
WFE-004-041
16.0 cm / 6 1/4"





Fluhrer
WFE-005-042
10.5 cm / 4 1/4"
1 mm Ø
of tin



Babcock
WFE-005-043
40.0 cm / 16"



WFE-005-044
Complete with 3 cones



WFE-005-045
Probe, Malleable, Only



WFE-005-046
Set of cones





Nabatoff
WFE-006-001
138x100x25 mm

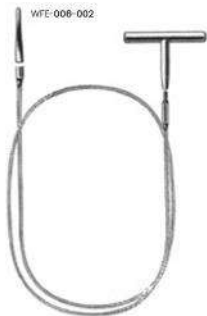

WFE-006-002

Olive Ø 3 mm
Olive Ø 6 mm
Olive Ø 9 mm
Olive Ø 12 mm
Olive Ø 15 mm
flexibles

Spare Parts



1/1

WFE-006-003
Ø 3 mm



WFE-006-004
Ø 6 mm



WFE-006-005
Ø 9 mm



WFE-006-006
Ø 12 mm



WFE-006-007
Ø 15 mm

Olive Ø 3 mm
Olive Ø 6 mm
Olive Ø 9 mm
Olive Ø 12 mm
Olive Ø 15 mm
Handle only
Cable, Flexible, stainless
Metal case

Olive Ø 3 mm
Olive Ø 6 mm
Olive Ø 9 mm
Olive Ø 12 mm
Olive Ø 15 mm
for traction flexible inoxidable





Fein
WFE-007-008
28.0 cm / 11"



WFE-007-009
45.0 cm / 17 3/4"



WFE-007-010
40.0 cm / 15 3/4"



Playfair
WFE-007-010
31.0 cm / 12 1/4"





Rabiner
WFE-008-001
23.0 cm / 9"
40 mm Ø



Buck
WFE-008-002
18.0 cm / 7"



Buck
WFE-008-003
18.0 cm / 7"



Special-Mobile
WFE-008-004
19.0 cm / 7 1/2"





1/2

Traemmer
WFE-009-005
24.0 cm / 9 1/2"



1/2

Neuro Duoflex
Mod. Dejerine
WFE-009-006
22.0 cm / 8 1/4"



1/2

Dejerine
WFE-009-007
20.0 cm / 8"



1/2

Dejerine
WFE-009-008
21.0 cm / 8 1/4"



1/2

Taylor
Mod. USA
WFE-009-009
20.0 cm / 8"



1/2

Berliner
WFE-009-010
20.0 cm / 8"





1/2

Aly
WFE-010-011
17.0 cm / 6 3/4"



1/2

Wartenberg
WFE-010-012
19.0 cm / 7 1/2"



1/2

Dejerine
WFE-009-008
21.0 cm / 8 1/4"



of wood

1/2

Pinard
WFE-010-014
18.0 cm / 7"



of aluminium

1/2

Pinard
WFE-010-015
15.0 cm / 6"



Vaccination & Puncture Trocars



1/2

Universal
WFE-011-001-3
set of 3 pieces

WFE-011-001-4
set of 4 pieces



1/2

Standard
11.0 cm / 4 1/8"

WFE-011-002 = 3 mm Ø
WFE-011-003 = 4 mm Ø
WFE-011-004 = 5 mm Ø
WFE-011-005 = 6 mm Ø



1/2

Standard
12.0 cm / 4 3/8"

WFE-011-006 = 3 mm Ø
WFE-011-007 = 4 mm Ø
WFE-011-008 = 5 mm Ø
WFE-011-009 = 6 mm Ø



1/2

Standard
12.0 cm / 4 3/8"

WFE-011-010 = 3 mm Ø
WFE-011-011 = 4 mm Ø
WFE-011-012 = 5 mm Ø
WFE-011-013 = 6 mm Ø





1/2

Duke
WFE-012-014
11.0 cm / 4 1/2"
5.5 mm Ø



1/2

Nelson
WFE-012-015-WFE-012-017
21.0 cm / 8 1/2"

1/1



WFE-012-015



WFE-012-016



WFE-012-017



1/2

Campbell
WFE-012-018
WFE-012-019
16.0 cm / 6 1/2"



1/1

WFE-012-018
6.0 mm Ø



WFE-012-019
6.0 mm Ø

1/2



1/2



Bulau
WFE-012-020
24.0 cm / 9 1/2"
8 mm Ø

1/1





Flourant
WFE-013-021
23.0 cm / 9"
5 mm Ø

Flourant
WFE-013-022
23.0 cm / 9"
5 mm Ø



Ochsner
14.0 cm / 5 1/2"
WFE-013-023 = 4 mm Ø
WFE-013-024 = 5.5 mm Ø
WFE-013-025 = 6.5 mm Ø



Billrot
WFE-013-026
24.0 cm / 10"
6 mm Ø



Vaccination & Puncture Suctions Tubes

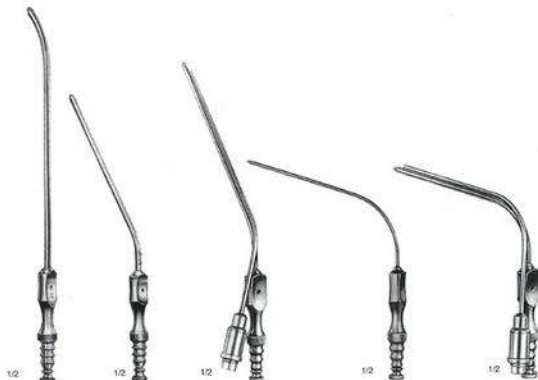

Adson
WFE-014-001
5 mm Ø
21.0 cm / 8 1/4"

Frazier
WFE-014-002-WFE-014-005
19.0 cm 7 1/2"

Frazier
WFE-014-006-WFE-014-007
19.0 cm 7 1/2"

Poppen
WFE-014-008-WFE-014-011
13.0 cm / 5"

Poppen
WFE-014-012-WFE-014-013
13.0 cm / 5"

Fr	Fr
6	WFE-014-002
8	WFE-014-003
10	WFE-014-004
12	WFE-014-005

Fr	Fr
8	WFE-014-006
10	WFE-014-007

Fr	Fr
6	WFE-014-008
8	WFE-014-009
10	WFE-014-010
12	WFE-014-011

Fr	Fr
8	WFE-014-012
10	WFE-014-013



Wullstein
WFE-014-014
14.0 cm / 5 1/2"



WFE-014-015



WFE-014-016



WFE-014-017

WFE-014-006-WFE-014-007 - with Fiber Optics

WFE-014-012-WFE-014-013 - with Fiber Optics

WFE-014-014 - Micro suction tube, complete, consisting of:

W-014-015 - Micro suction cannula, Ø 0.4 mm

WFE-014-016 - Ditto Ø 0.6 mm

WFE-014-017 - Ditto Ø 0.8 mm



Vaccination & Puncture Suctions Tubes



1/2

Gomel
WFE-015-018
15.0 cm / 6"



1/2

Hepp/Scheidel
WFE-015-019
22.5 cm / 9"



1/2

WFE-015-020
16.5 cm / 6 1/2"



1/2

WFE-015-021
6.5 cm / 2 1/2"

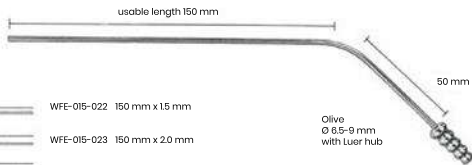

- WFE-015-022 150 mm x 1.5 mm
- WFE-015-023 150 mm x 2.0 mm
- WFE-015-024 150 mm x 2.5 mm
- WFE-015-025 150 mm x 3.5 mm

Olive
Ø 8.5-9 mm
with Luer hub

Yasargill
WFE-015-022-WFE-015-025
11.0 cm / 4 3/8"

- Irrigator for Microsurgery
- Irrigator/Aspirator complete with cannula
- Irrigator/Aspirator only
- Suction and Irrigation, Cannula only



Vaccination & Puncture Suctions Tubes



Yankauer
WFE-016-026
27 cm / 11"



Fig. 0
WFE-016-029



Fig. 1
WFE-016-030



Fig. 2
WFE-016-031



Fig. 3
WFE-016-032



Yankauer
WFE-016-027
27 cm / 11"
Fig. 0.3



WFE-016-028



Vaccination & Puncture Suctions Tubes



Vaccination & Puncture Suctions Tubes



6 mm
round

6 mm
Oval



WFE-018-043
1.5 mm Ø

WFE-018-044
2.0 mm Ø

WFE-018-045
2.5 mm Ø

WFE-018-046
3.5 mm Ø



WFE-018-047
1.5 mm Ø

WFE-018-048
2.0 mm Ø

WFE-018-049
2.5 mm Ø

WFE-018-050
3.5 mm Ø

with additional side holes

2.0 mm Ø



1/2

1/2

1/2

1/2

1/1

1/2

1/1

Nuboer
WFE-018-040
21.0 cm / 8 1/4"

Nuboer
WFE-018-041
21.0 cm / 8 1/4"

Coupland
WFE-018-042
17.0 cm / 6 3/4"

WFE-018-051
1.5 mm Ø

WFE-018-052
2.5 mm Ø

WFE-018-053
3.5 mm Ø



1/2

1/2

Byrd
WFE-018-051-WFE-018-053
20.0 cm / 8"

Cogswell
WFE-018-054
23.0 cm / 9"



WORTH FIELD
ENTERPRISES



BLUNT/BLUNT

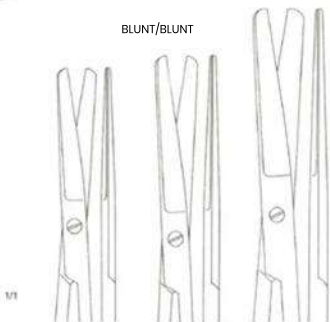

WFE-019-001
10.5 cm / 4 1/8"

WFE-019-002
11.5 cm / 4 1/2"

WFE-019-003
13.0 cm / 5"



Standard
WFE-019-001-WFE-019-008

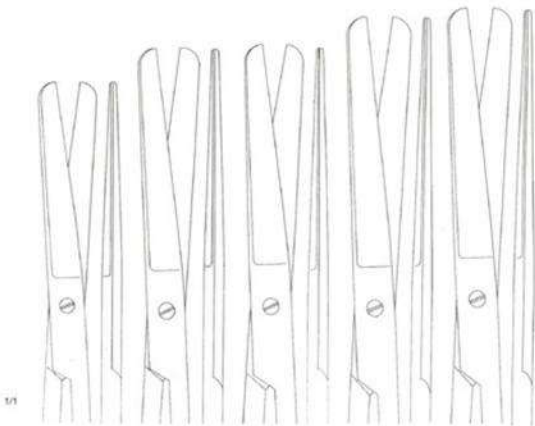

WFE-019-004
14.0 cm / 5 1/2"

WFE-019-005
15.5 cm / 6"

WFE-019-006
16.5 cm / 6 1/2"

WFE-019-007
18.5 cm / 7 1/4"

WFE-019-008
20.0 cm / 8"





SHARP/BLUNT

1/1



WFE-020-009
10.5 cm / 4 1/4"



WFE-020-010
11.5 cm / 4 1/2"



WFE-020-011
13.0 cm / 5"



Standard
WFE-020-009-WFE-020-016

1/1



WFE-019-012
14.0 cm / 5 1/2"



WFE-020-013
15.5 cm / 6"

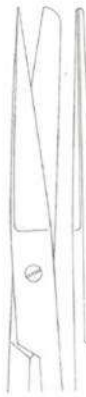

WFE-020-014
16.5 cm / 6 1/2"



WFE-020-015
18.5 cm / 7 1/4"



WFE-020-016
20.0 cm / 8"





SHARP/SHARP



Standard
WFE-021-017-WFE-021-022

1/1



WFE-021-017
10.5 cm / 4 1/8"

WFE-021-018
11.5 cm / 4 1/2"

WFE-021-019
13.0 cm / 5"

WFE-021-020
14.0 cm / 5 1/2"

WFE-021-021
15.5 cm / 6"

WFE-021-025
18.5 cm / 6 1/2"





BLUNT/BLUNT

1/1

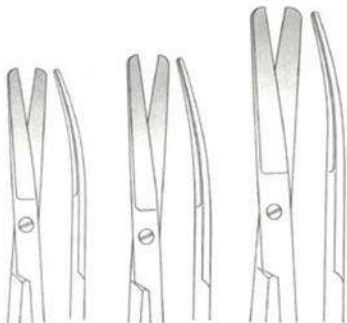

WFE-022-023
11.5 cm / 4 1/2"

WFE-022-024
13.0 cm / 5"

WFE-022-025
14.0 cm / 5 1/2"

1/1



Standard
WFE-022-023-WFE-022-029

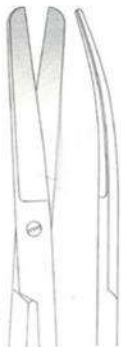

WFE-022-026
15.5 cm / 6"

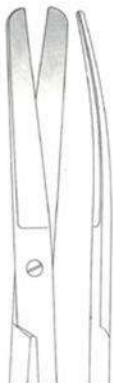

WFE-022-027
16.5 cm / 6 1/2"

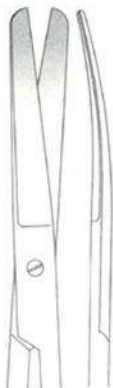

WFE-028-028
18.5 cm / 7 1/2"

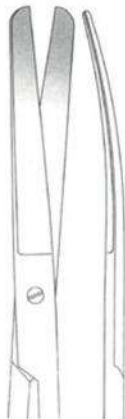

WFE-022-029
20.0 cm / 8"





SHARP/BLUNT

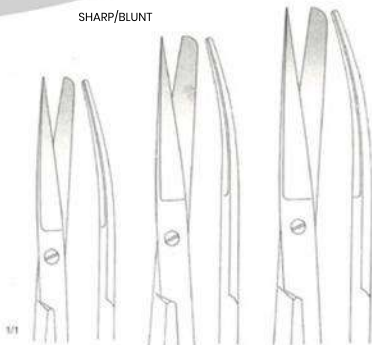

WFE-023-030
11.5 cm / 4 1/2"

WFE-023-031
13 cm / 5"

WFE-023-032
14.0 cm / 5 1/2"



Standard
WFE-023-030-WFE-023-036

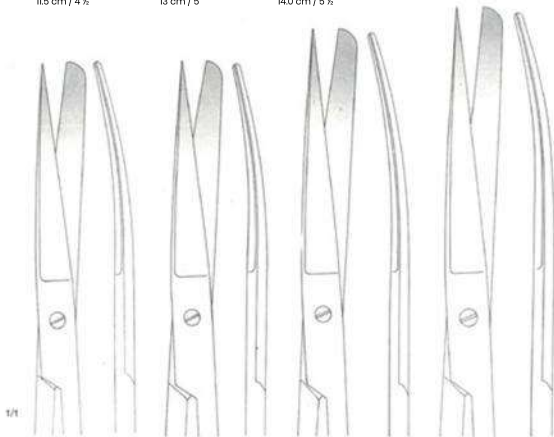

WFE-023-033
15.5 cm / 6"

WFE-023-034
16.5 cm / 6 1/2"

WFE-023-035
18.5 cm / 6 3/4"

WFE-023-036
20.0 cm / 8"





SHARP/SHARP

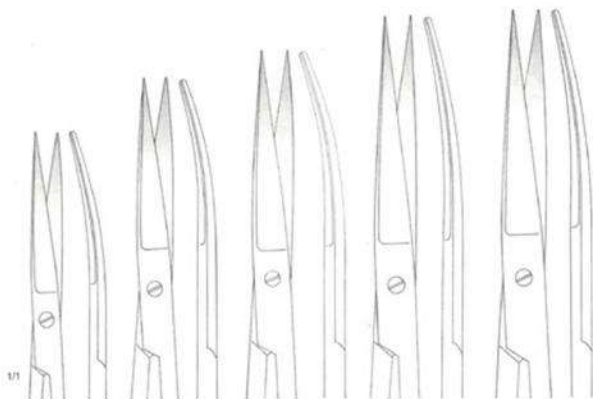

WFE-024-037
11.5 cm / 4 1/2"

WFE-024-038
13.0 cm / 5"

WFE-024-039
14.0 cm / 5 1/2"

WFE-024-040
15.5 cm / 6"

WFE-024-041
16.5 cm / 6 1/2"

Standard
WFE-024-037-WFE-024-041





WFE-024-037-WFE-024-041

Incision Scissors



WFE-025-042
13.0 cm / 5"

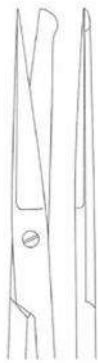

WFE-025-043
14.0 cm / 5 1/2"



1/2

Deaver
WFE-025-045-WFE-025-045

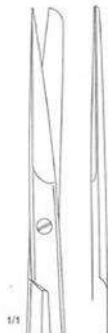

1/5

WFE-025-044
14.0 cm / 5 1/2"

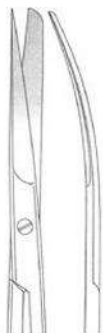

WFE-025-045
14.0 cm / 5 1/2"





Mayo
WFE-026-046-WFE-026-053

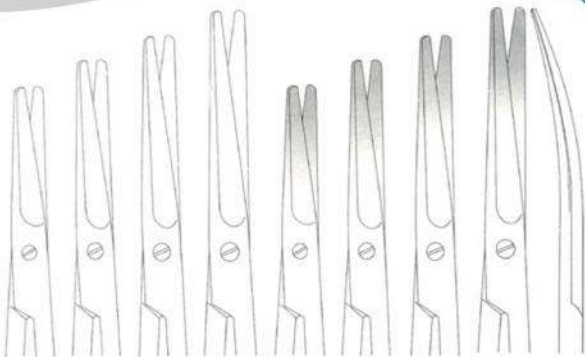

WFE-026-046 14.0 cm / 5 1/2" WFE-026-047 15.0 cm / 6" WFE-026-048 17.0 cm / 6 1/4" WFE-026-049 23.0 cm / 9" WFE-026-050 14.0 cm / 5 1/2" WFE-026-051 15.0 cm / 6" WFE-026-052 17.0 cm / 6 1/4" WFE-026-053 23.0 cm / 9"



Mayo-Harrington
WFE-026-054-WFE-026-056

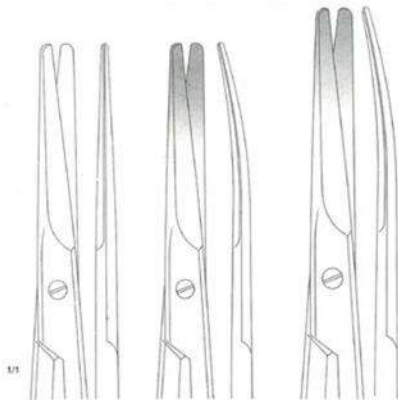

WFE-026-054 22.5 cm / 9" WFE-026-055 22.5 cm / 9" WFE-026-056 30.0 cm / 12"





WFE-027-057
15.0 cm / 6"



WFE-027-058
17.0 cm / 6 3/4"



Mayo-Style
WFE-027-057-WFE-027-060



WFE-027-059
15.0 cm / 6"



WFE-027-060
17.0 cm / 6 3/4"



General Instruments Operating Scissors



1/1



WFE-028-061
16.0 cm / 6 1/4"



WFE-028-062
19.0 cm / 7 1/2"



WFE-028-063
21.0 cm / 8 1/4"



Mayo-Style
WFE-028-061-WFE-028-066

1/1



WFE-028-064
16.0 cm / 6 1/4"

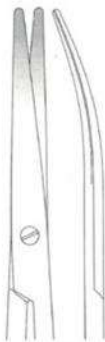

WFE-028-065
19.0 cm / 7 1/2"



WFE-028-066
21.0 cm / 8 1/4"





Mayo-Noble
WFE-029-067-WFE-029-068
17.0 cm / 6 3/4"

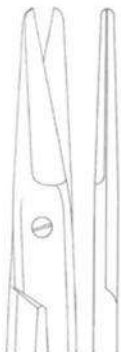

WFE-029-067

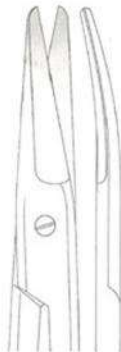

WFE-029-068



Wertheim
WFE-029-069-WFE-029-071

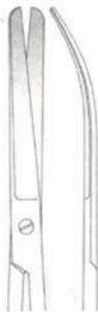

WFE-029-069
14.0 cm / 5 1/2"



WFE-029-070
19.5 cm / 7 3/4"



WFE-029-071
22.5 cm / 9"





1/1

Kelly
WFE-030-072-WFE-030-075

1/1



WFE-030-072
16.0 cm / 6 1/4"

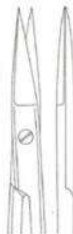

WFE-030-073
18.0 cm / 7"



WFE-030-074
16.0 cm / 6 1/4"

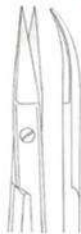

WFE-030-075
18.0 cm / 7"



Doyen
WFE-030-076-WFE-030-077

1/1



WFE-030-076
17.5 cm / 7"

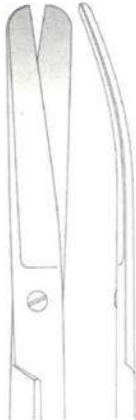

WFE-030-077
17.0 cm / 6 3/4"





Metzenbaum
WFE-031-078-WFE-031-079
11.5 cm / 4 1/2"



WFE-031-078



WFE-031-079



Metzenbaum
WFE-031-080-WFE-031-081
15.0 cm / 6"



WFE-031-080



WFE-031-081



Metzenbaum
WFE-031-082-WFE-031-087
14.0 cm / 5 1/2"



WFE-031-082



WFE-031-083



WFE-031-084



WFE-031-085



WFE-031-086



WFE-031-087



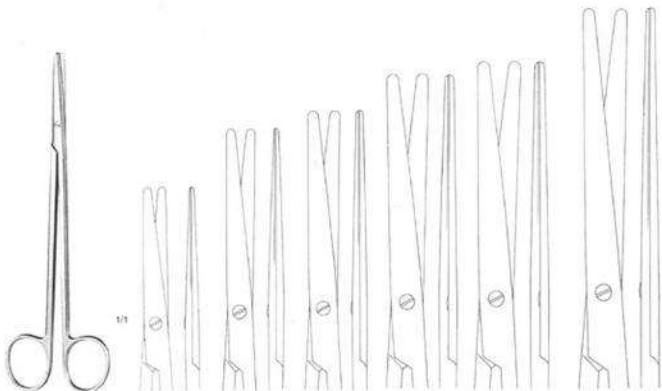

Metzenbaum-Neison
WFE-032-088-WFE-032-093

WFE-032-088
18.0 cm / 7"

WFE-032-089
20.0 cm / 8"

WFE-032-090
23.0 cm / 9"

WFE-032-091
25.0 cm / 10"

WFE-032-092
28.0 cm / 11"

WFE-032-093
30.0 cm / 12"

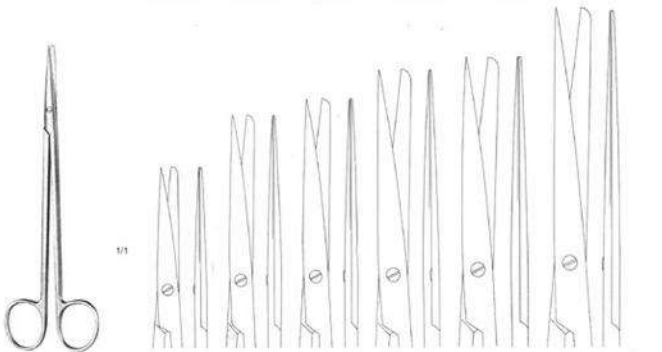

Metzenbaum-Neison
WFE-032-094-WFE-032-099

WFE-032-094
18.0 cm / 7"

WFE-032-095
20.0 cm / 8"

WFE-032-096
23.0 cm / 9"

WFE-032-097
25.0 cm / 10"

WFE-032-098
28.0 cm / 11"

WFE-032-099
30.0 cm / 12"





Metzenbaum-Neison
WFE-033-100-WFE-033-105

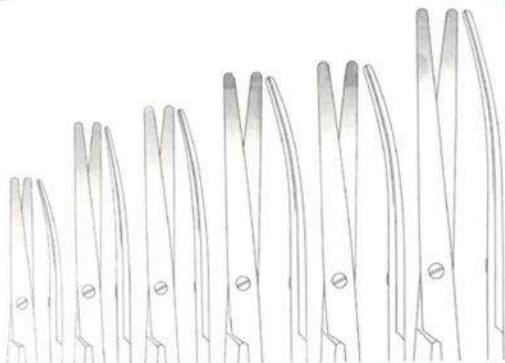

WFE-033-100 18.0 cm / 7"
WFE-033-101 20.0 cm / 8"
WFE-033-102 23.0 cm / 9"
WFE-033-103 25.0 cm / 10"
WFE-033-104 28.0 cm / 11"
WFE-033-105 30.0 cm / 12"



Metzenbaum-Neison
WFE-033-106-WFE-033-111

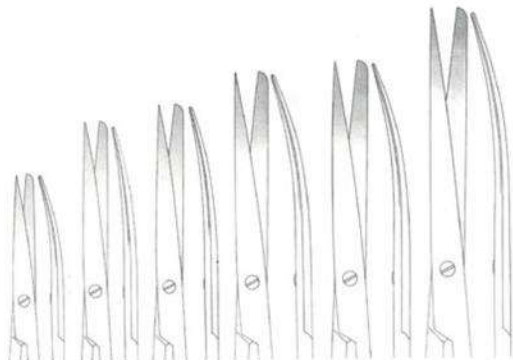

WFE-033-106 18.0 cm / 7"
WFE-033-107 20.0 cm / 8"
WFE-033-108 23.0 cm / 9"
WFE-033-109 25.0 cm / 10"
WFE-033-110 28.0 cm / 11"
WFE-033-111 30.0 cm / 12"





Fomon
WFE-034-112
13.5 cm / 5 1/4"

Fine Operating Scissors

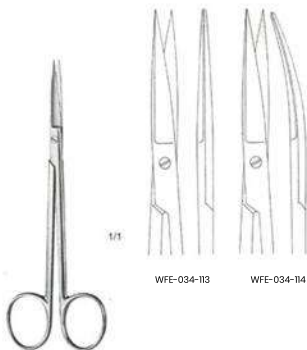

Joseph
WFE-034-113 - WFE-034-114
14.0 cm / 5 1/2"





WORTH FIELD
ENTERPRISES





Crafoord
WFE-036-123
30.0 cm / 12"

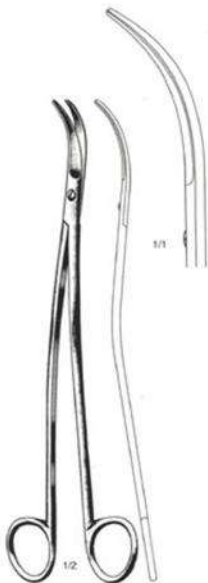

Satinsky
WFE-036-124
24.5 cm / 10"

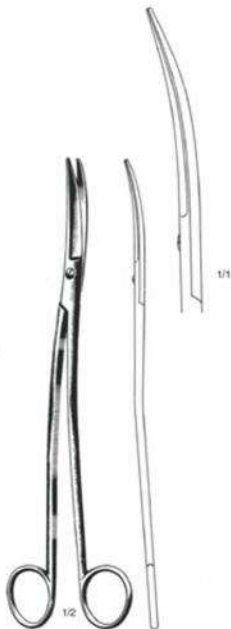

Klinkenbergh-loth
WFE-036-125
23.0 cm / 9"





Dietrich
WFE-037-126-WFE-037-130



WFE-037-126
18.0 cm / 7"



WFE-037-127
18.0 cm / 7"



WFE-037-128
17.5 cm / 7"



WFE-037-129
17.0 cm / 6 3/4"



WFE-037-130
17.0 cm / 6 3/4"



Dietrich
WFE-037-131
17.0 cm / 6 3/4"



General Instruments Thorax Vascular Scissors



Potts-Smith
WFE-038-132-WFE-038-134
19.0 cm / 7 1/2"



WFE-038-132
19.0 cm / 7 1/2"

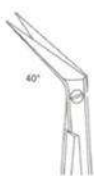

WFE-038-133
19.0 cm / 7 1/2"



WFE-038-134
19.0 cm / 7 1/2"



Potts- de Martel
WFE-038-135-WFE-038-136



WFE-038-135
21.0 cm / 8 1/4"



WFE-038-136
24.0 cm / 9 1/2"

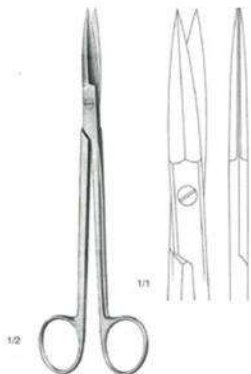

Mc Indoe
WFE-038-137
19.0 cm / 7 1/2"



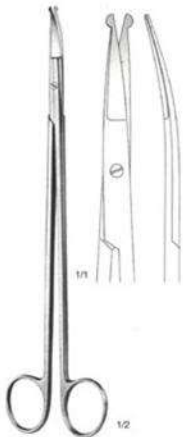

Strully
WFE-039-001
22.0 cm / 8½"

• Neurosurgical Scissors



Dandy
WFE-039-002
17.0 cm / 6¾"

• Neurosurgical Scissors

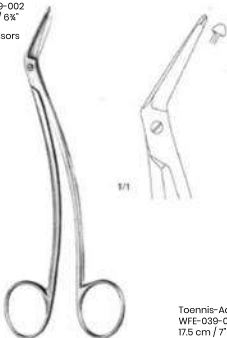

Schmieden-Taylor 1/2
WFE-039-003
17.0 cm / 6¾"

• Dura Scissors



Toennis-Adson
WFE-039-004
17.5 cm / 7"

• Dissecting Scissors



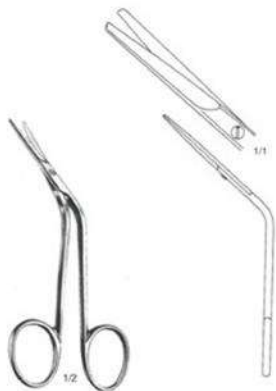

Formon
WFE-040-005
15.0 cm / 6"



Cottle
WFE-040-006
16.0 cm / 6 1/2"



Heymann
WFE-040-007
18.0 cm / 7"



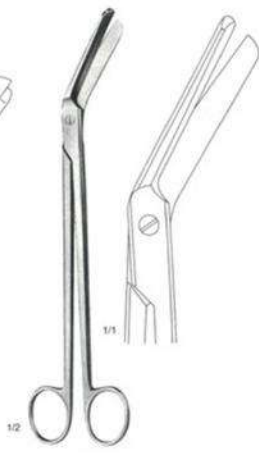
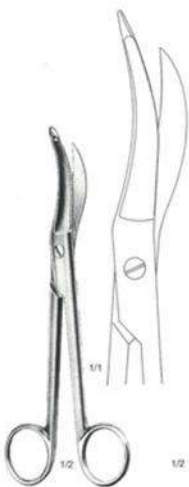

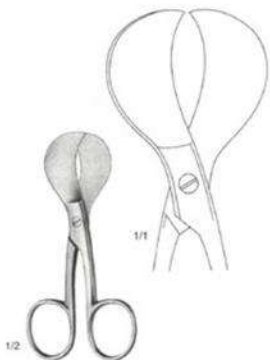

1/2

Mod, USA
WFE-042-001
10.5 cm / 4 1/4"



1/2

Schuhmacher
WFE-042-002
15.0 cm / 6"



1/2

Busch
WFE-042-003
16.0 cm / 6 3/8"





WFE-043-001
16.0 cm / 6 1/4"

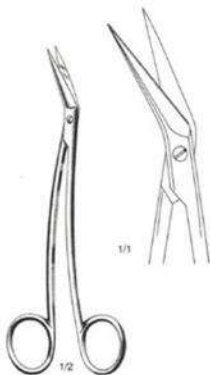

Locklin
WFE-043-002
16.0 cm / 6 1/4"



Quinby
WFE-043-003
12.5 cm / 5"

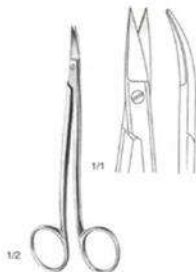

Neumann
WFE-043-004
12.0 cm / 4 3/4"



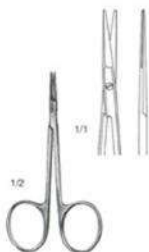

WFE-044-001
9.0 cm / 3 1/2"

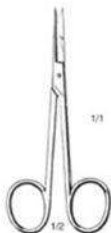

WFE-044-002-WFE-044-005
11.5 cm / 4 1/2"

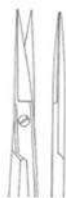

WFE-044-002



WFE-044-003



WFE-044-004



WFE-044-005



WFE-044-006-WFE-044-007
12.0 cm / 4 3/4"



WFE-044-006



WFE-044-007



General Instruments Fine Operating Scissors

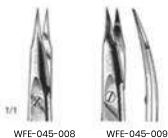

WFE-045-008

WFE-045-009



WFE-045-012

WFE-045-013



1/2



WFE-045-010

WFE-045-011



1/2

Tenotomy Scissors
WFE-045-010-WFE-045-011
11.0 cm / 4 1/4"

Strabismus Scissors
WFE-045-012-WFE-045-013
11.5 cm / 4 1/2"



1/2



1/1

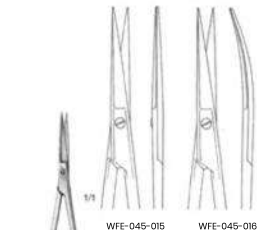

WFE-045-015

WFE-045-016



1/2

1/1

Enucleation Scissors
WFE-045-014
11.0 cm / 4 1/4"

Dissecting Scissors
WFE-045-015-WFE-045-016
11.0 cm / 4 1/4"
(Post mortem)

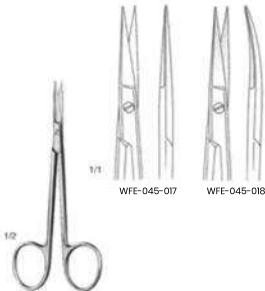

1/1

WFE-045-017

WFE-045-018

1/2



Iris Scissors
WFE-045-017-WFE-045-018
11.0 cm / 4 1/4"



General Instruments Ligature Scissors



Spencer
WFE-046-001
9.0 cm / 3 1/2"



Spencer
WFE-046-002
13.0 cm / 5"



Littauer
WFE-046-003
14.0 cm / 5 1/2"



Universal
WFE-046-004
12.0 cm / 4 1/2"

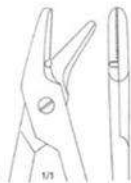

WFE-046-005-WFE-046-008

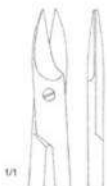

WFE-046-005
10.0 cm / 4"



WFE-046-006
10.0 cm / 4"

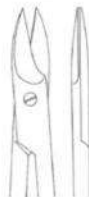

WFE-046-007
12.0 cm / 4 1/2"

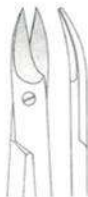

WFE-046-008
12.0 cm / 4 1/2"

1 blade saw edge

1 blade saw edge



General Instruments Dressing Forceps

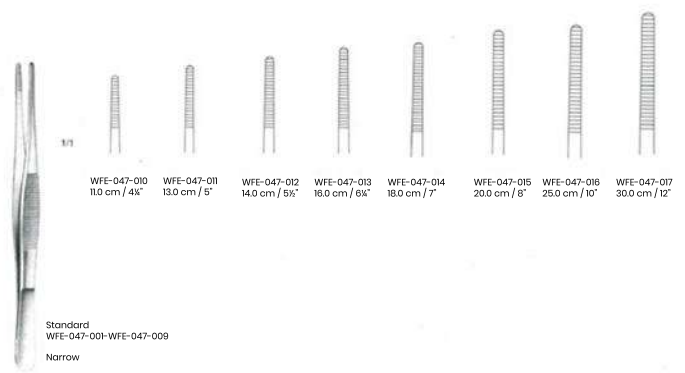
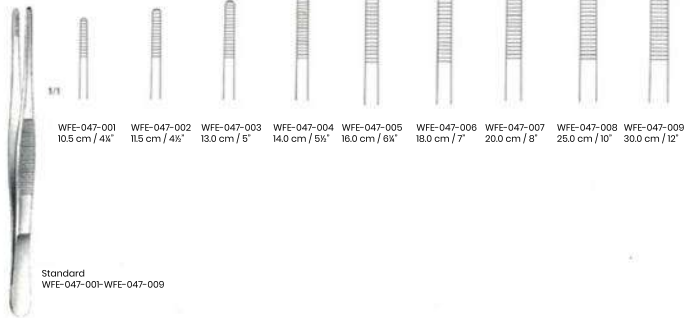



1/1

WFE-048-001
12.0 cm / 4 3/4"

WFE-048-002
13.0 cm / 5"

WFE-048-003
14.0 cm / 5 1/2"

WFE-048-004
15.0 cm / 6"

WFE-048-005
18.0 cm / 7"

WFE-048-006
21.0 cm / 8 1/4"

WFE-048-007
25.0 cm / 10"

WFE-048-008
31.0 cm / 12 1/4"

Standard
WFE-048-001-WFE-048-008



1/1

WFE-048-009
12.0 cm / 4 3/4"

WFE-048-010
13.0 cm / 5"

WFE-048-011
14.0 cm / 5 1/2"

WFE-048-012
15.0 cm / 6"

Standard
WFE-048-009-WFE-048-012



1/1

WFE-048-013
12.0 cm / 4 3/4"

WFE-048-014
15.0 cm / 6"

Adson
WFE-048-013-WFE-048-014



1/1

McIndoe
WFE-048-014
15.0 cm / 6"



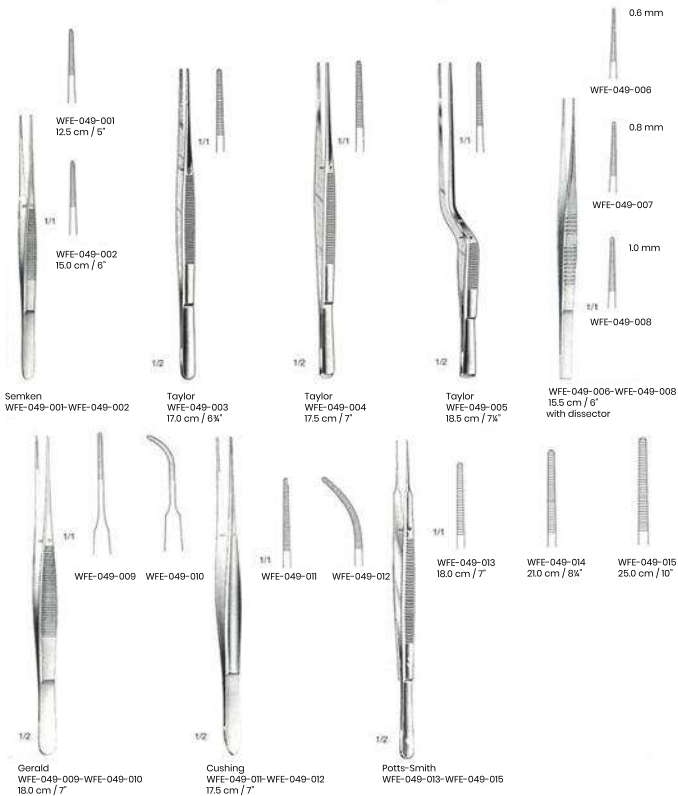



WFE-050-001 10.5 cm / 4"
 WFE-050-002 11.5 cm / 4½"
 WFE-050-003 13.5 cm / 5"
 WFE-050-004 14.0 cm / 5½"
 WFE-050-005 16.0 cm / 6¼"
 WFE-050-006 18.0 cm / 7"
 WFE-050-007 20.0 cm / 8"
 WFE-050-008 25.0 cm / 10"
 WFE-050-009 30.0 cm / 12"

WFE-050-001-WFE-050-009
 1x2 Teeth



WFE-050-010 11.5 cm / 4½"
 WFE-050-011 13.5 cm / 5"
 WFE-050-012 14.0 cm / 5½"
 WFE-050-013 16.0 cm / 6¼"
 WFE-050-014 18.0 cm / 7"
 WFE-050-015 20.0 cm / 8"
 WFE-050-016 25.0 cm / 10"

WFE-050-010-WFE-050-016
 2x3 Teeth





WFE-051-001
13.0 cm / 5"

WFE-051-002
14.0 cm / 5½"

WFE-051-003
16.0 cm / 6¼"

WFE-051-001-WFE-051-003
3x4 Teeth



WFE-051-004
13.0 cm / 5"

WFE-051-005
14.0 cm / 5½"

WFE-051-006
16.0 cm / 6¼"

WFE-051-004-WFE-051-006
4x5 Teeth

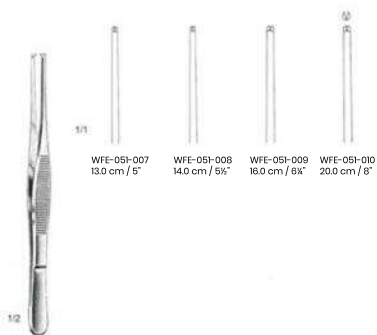

WFE-051-007
13.0 cm / 5"

WFE-051-008
14.0 cm / 5½"

WFE-051-009
16.0 cm / 6¼"

WFE-051-010
20.0 cm / 8"

WFE-051-007-WFE-051-010
1x2 Teeth



WFE-051-011
13.0 cm / 5"

WFE-051-012
14.0 cm / 5½"

WFE-051-011-WFE-051-012
1x2 Teeth



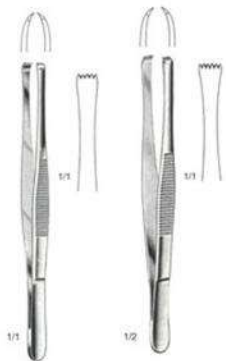

Stone
WFE-052-001
15.0 cm / 6"
4x5 Teeth

Stone
WFE-052-002
15.0 cm / 6"
5 x5 Teeth

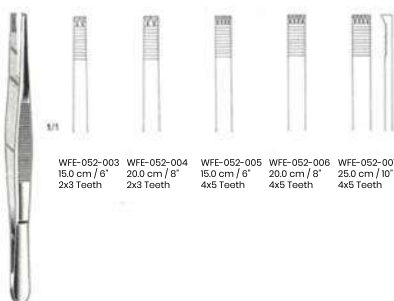

Adlerkreutz
WFE-052-003-WFE-052-007

WFE-052-003
15.0 cm / 6"
2x3 Teeth

WFE-052-004
20.0 cm / 8"
2x3 Teeth

WFE-052-005
15.0 cm / 6"
4x5 Teeth

WFE-052-006
20.0 cm / 8"
4x5 Teeth

WFE-052-007
25.0 cm / 10"
4x5 Teeth

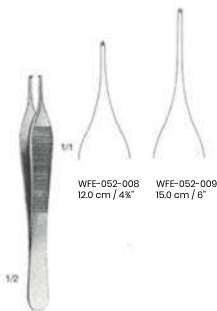

WFE-052-008
12.0 cm / 4 3/4"

WFE-052-009
15.0 cm / 6"

Adson
WFE-052-008-WFE-052-009
1x2 Teeth



Gillies
WFE-052-010
15.0 cm / 6"
1x2 Teeth



General Instruments Tissue Forceps

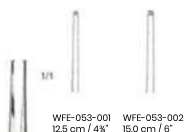

Sernken
WFE-053-001-WFE-053-002
1x2 Teeth



Taylor
WFE-053-003
17.5 cm / 7"
1x2 Teeth



Taylor
WFE-053-004
17.5 cm / 7"
1x2 Teeth



Taylor
WFE-053-005
17.5 cm / 7"
1x2 Teeth

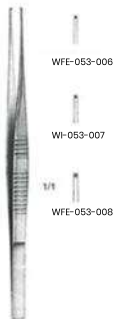

WFE-053-006-WFE-053-008
15.0 cm / 6"



Gerlald
WFE-053-009-WFE-053-0010
17.0 cm / 6 3/4"



Cushing
WFE-053-011
17.0 cm / 6 3/4"



Potts-Smith
WFE-053-012-WFE-053-014





Brophy
WFE-054-001
20.0 cm / 8"



Adson-Brown
WFE-054-002
20.0 cm / 4"



Micro-Adson
WFE-054-003
12.0 cm / 4"

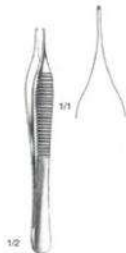

Micro-Adson
WFE-054-004
12.0 cm / 4"



Micro-Adson
WFE-054-005
11.0 cm / 4"
Teeth Extremely Delicate



Duvall
WFE-054-006
14.0 cm / 5"



Russ, Modell
WFE-054-009-WFE-054-009



WFE-054-007
15.0 cm / 6"



WFE-054-008
20.0 cm / 8"



WFE-054-009
25.0 cm / 10"





Bonney
WFE-055-001-WFE-055-002
18.0 cm / 7"



WFE-055-001
1x2 Teeth



WFE-055-002
2x3 Teeth



Ferris-Smith
WFE-055-003-WFE-055-004
18.0 cm / 7"



WFE-055-003
1x2 Teeth



WFE-055-004
2x3 Teeth



Maryo-Russ
WFE-055-004
23.0 cm / 9"



1/1

1/2

Grasping Forceps





Yasargil
WFE-056-001-WFE-056-002



Yasargil
WFE-056-003-WFE-056-004



Heifetz
WFE-056-005-WFE-056-006



General Instruments Splinter Forceps Cilia Forceps



WFE-057-001
12.5 cm / 5"



Föllchenföhl
WFE-057-002-WFE-057-004



WFE-057-002
7.5 cm / 3"



WFE-057-003
9.0 cm / 3 1/2"



WFE-057-004
11.5 cm / 4 1/2" *



Hunter
WFE-057-005-WFE-057-008
10.5 cm / 4 1/4"



WFE-057-005



WFE-057-006



WFE-057-007



WFE-057-008

Walter-Carmalt
WFE-057-007-WFE-057-008
10.5 cm / 4 1/4"



WFE-057-009
12.0 cm / 4 3/4"



WFE-057-010
10.0 cm / 4"



WFE-057-011
10.0 cm / 4"





Shaaf
WFE-058-012
9.0 cm / 3 1/2"



Littauer
WFE-058-013
8.5 cm / 3 1/4"



WFE-058-014
9.0 cm / 3 1/2"



Douglas
WFE-058-015
9.0 cm / 3 1/2"



Douglas
WFE-058-016
9.0 cm / 3 1/2"



General Instruments Bulldog Clamps



WFE-059-001
6.0 cm / 2½"



WFE-059-004
6.0 cm / 2½"



WFE-059-002
3.5 cm / 1½"



WFE-059-001
3.5 cm / 1½"



WFE-059-001
5.0 cm / 2"



WFE-059-001
5.0 cm / 2"



Dieffenbach
WFE-059-001-WFE-059-006



Johns Hopkins
WFE-059-007-WFE-059-009



WFE-059-007
5.0 cm / 2"



WFE-059-008
6.5 cm / 2½"



WFE-059-009
7.5 cm / 3"



WFE-059-010-WFE-059-015



	WFE-059-010	WFE-059-011	WFE-059-012		WFE-059-013	WFE-059-014	WFE-059-015
Length	50 mm	50 mm	60 mm		50 mm	50 mm	60 mm
Jaws	8 mm	12 mm	20 mm		8 mm	12 mm	20 mm
Weight	3 gr.	3 gr.	3 gr.		3 gr.	3 gr.	3 gr.
Pressure	50 gr.	50 gr.	50 gr.		50 gr.	50 gr.	50 gr.



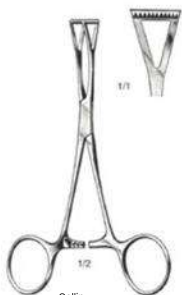

Collin
WFE-060-001t
14.0 cm / 5 1/2"



Collin
WFE-060-001
18.5 cm / 6 3/4"

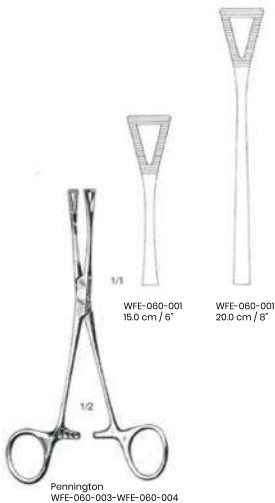

WFE-060-001
15.0 cm / 6"

WFE-060-001
20.0 cm / 8"

Pennington
WFE-060-003-WFE-060-004





Baby-Mixer
WFE-061-001 - WFE-061-002
14.0 cm / 5 1/2"



Hartmann
WFE-061-003 - WFE-061-004
10.0 cm / 4"

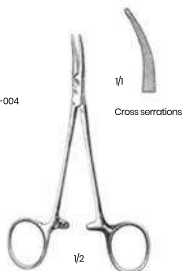

WFE-061-005
12.0 cm / 4 3/4"

Cross serrations



Halsted-Mosquito
WFE-061-006 - WFE-061-013

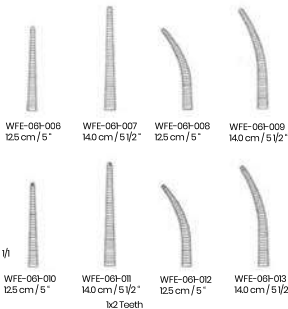



Halsted-Mosquito
WFE-062-001 - WFE-062-008

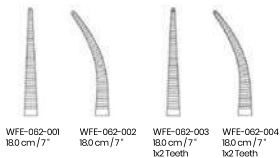

WFE-062-001 18.0 cm / 7"
WFE-062-002 18.0 cm / 7"
WFE-062-003 18.0 cm / 7"
WFE-062-004 18.0 cm / 7"

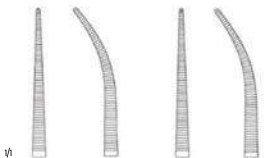

WFE-062-005 21.0 cm / 8 1/4"
WFE-062-006 21.0 cm / 8 1/4"
WFE-062-007 21.0 cm / 8 1/4"
WFE-062-008 21.0 cm / 8 1/4"



Micro-Mosquito
WFE-062-009 - WFE-062-016

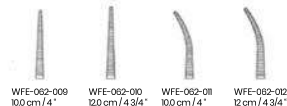

WFE-062-009 10.0 cm / 4"
WFE-062-010 12.0 cm / 4 3/4"
WFE-062-011 10.0 cm / 4"
WFE-062-012 12.0 cm / 4 3/4"

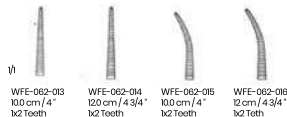

WFE-062-013 10.0 cm / 4"
WFE-062-014 12.0 cm / 4 3/4"
WFE-062-015 10.0 cm / 4"
WFE-062-016 12.0 cm / 4 3/4"





Provideco-Hospital
WFE-063-017 - WFE-063-018
14.0 cm / 5 1/2"

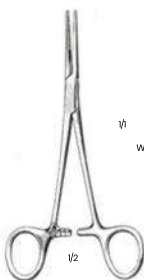

Kelly
WFE-063-019 - WFE-063-020
14.0 cm / 5 1/2"

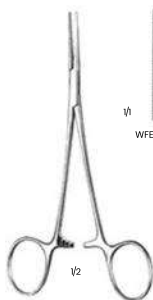

Lorigo
WFE-063-021 - WFE-063-024
15.0 cm / 6"

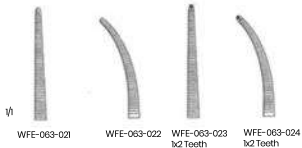



Rankin-Kelly
WFE-064-025 - WFE-064-026
16.0 cm / 6 1/4"

1/1



WFE-064-025



WFE-064-026



Bobby-Overholt
WFE-064-027
13.5 cm / 5 1/4"

1/1



WFE-064-027



Crile
WFE-064-028 - WFE-064-031
14.0 cm / 5 1/2"

1/1



WFE-064-028



WFE-064-029



WFE-064-030
1x2 Teeth



WFE-064-031
1x2 Teeth



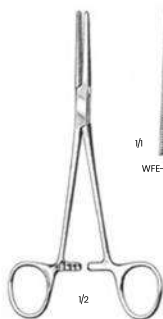

WFE-065-032



WFE-065-033

Rankin-Crile
WFE-065-032 - WFE-065-033
16.0 cm / 6 3/4"



WFE-065-034



WFE-065-035
1/2 Teeth

Lovelace
WFE-065-034 - WFE-065-035



Mosquito-Dandy
WFE-065-036
12.0 cm / 4 3/4"

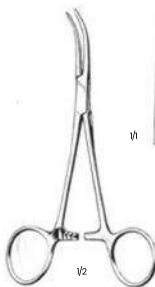

WFE-065-037

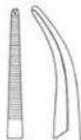

WFE-065-038
1/2 Teeth

Dandy
WFE-065-037 - WFE-065-038





Adson
WFE-066-001 - WFE-066-002
18.5 cm / 7 1/4"
1x2 Tooth

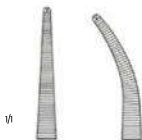

WFE-066-001 WFE-066-002



Rochester-Carmalt
WFE-066-003 - WFE-066-006



WFE-066-003 WFE-066-004 WFE-066-005 WFE-066-006
16.0 cm / 6 1/4" 20.0 cm / 8" 16.0 cm / 6 1/4" 20.0 cm / 8"





Páan
WFE-067-007 - WFE-067-012
Delicate Pattern

ψ



WFE-067-007
13.0 cm / 5"



WFE-067-008
14.0 cm / 5 1/2"



WFE-067-009
16.0 cm / 6 1/4"



WFE-067-010
13.0 cm / 5"



WFE-067-011
14.0 cm / 5 1/2"



WFE-067-012
16.0 cm / 6 1/4"



Kocher
WFE-067-013 - WFE-067-018
Delicate Pattern

ψ



WFE-067-013
13.0 cm / 5"



WFE-067-014
14.0 cm / 5 1/2"



WFE-067-015
16.0 cm / 6 1/4"



WFE-067-016
13.0 cm / 5"



WFE-067-017
14.0 cm / 5 1/2"



WFE-067-018
16.0 cm / 6 1/4"



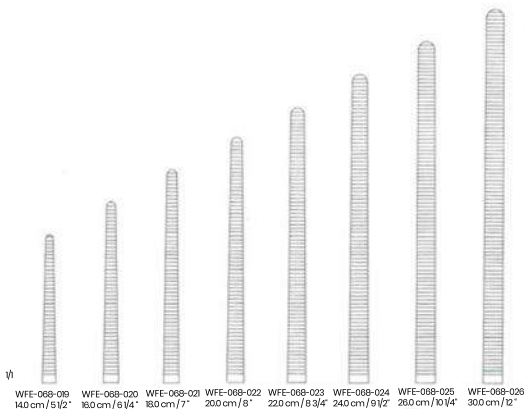

Rochester-Pócan
WFE-067-029 - WFE-067-034

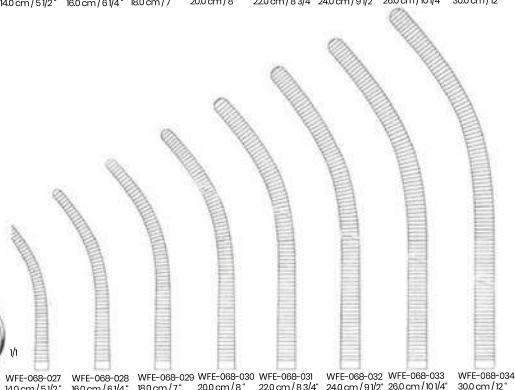

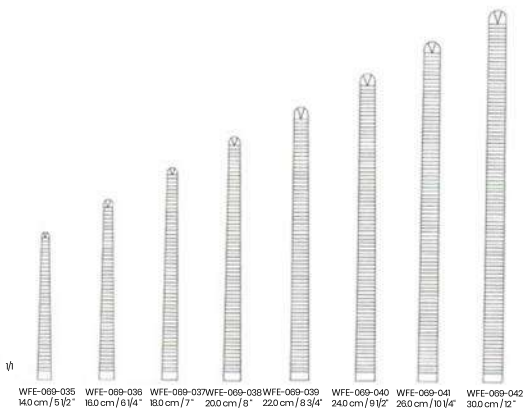

Kocher (Ochsner)
 WFE-069-035 - WFE-069-050
 1x2 Teeth

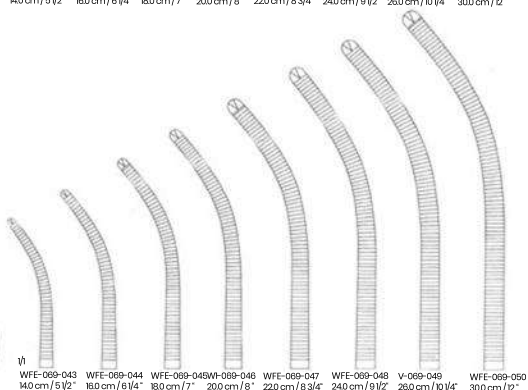

General Instruments Artery Dissecting & Ligature Forceps



Baby-Mixer
WFE-070-001
18.0 cm / 7"

1/2



1/1



Baby-Adson
WFE-070-001 - WFE-070-003

1/2



1/1

WFE-070-002
14.0 cm / 5 1/2"



WFE-070-003
18.0 cm / 7"



Hobbs
WFE-070-004 - WFE-070-006

1/2



1/1

WFE-070-004



WFE-070-005



WFE-070-006



1/2



1/1



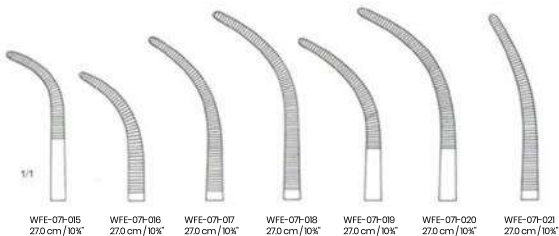
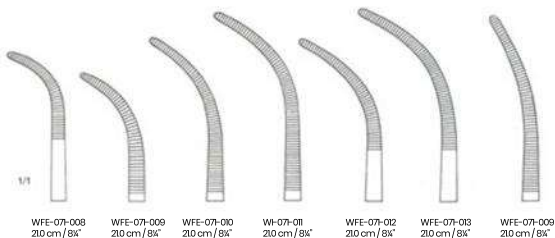

Overholt-Gelssendoerfer
WFE-07-008-WFE-07-021



General Instruments Dissecting & ligature Forceps



Mini-Gemini
WFE-072-022-WFE-072-025



WFE-072-022
18.0 cm / 7"



WFE-072-023
22.0 cm / 7 3/4"



WFE-072-024
25.0 cm / 10"



WFE-072-025
28.0 cm / 11"



Mini-Gemini
WFE-072-026-WFE-072-032



WFE-072-026
13.0 cm / 5"



WFE-072-027
16.0 cm / 6 1/4"



WFE-072-028
18.0 cm / 7"



WFE-072-029
20.0 cm / 8"



WFE-072-030
23.0 cm / 9"



WFE-072-031
25.0 cm / 10"



WFE-072-032
28.0 cm / 11"



General Instruments Artery Forceps, Bronchus & Gall Duct Clamps



Mister
WFE-073-001-WFE-073-002

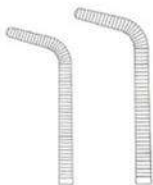

WFE-073-001 15.0 cm / 6"
WFE-073-000 18.0 cm / 7"



Mister-O'Shaughnessy
WFE-073-003
18.0 cm / 7"



1/2



Mister
WFE-073-004
22.0 cm / 8 1/2"



1/1



Mister
WFE-073-005
23.0 cm / 9"



1/1



General Instruments Artery Forceps, Bronchus & Gall Duct Clamps

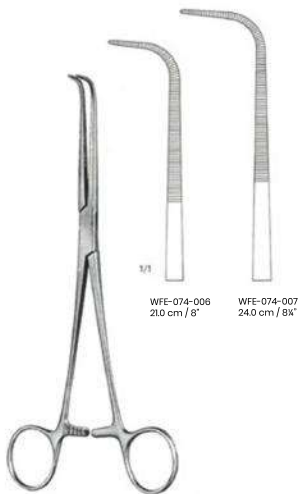

1/1

WFE-074-006
21.0 cm / 8"

WFE-074-007
24.0 cm / 8 3/4"

Wickstrom
WFE-074-006-WFE-074-007



1/2

Mixer
WFE-074-008-WFE-074-010



1/1

WFE-074-008
22.0 cm / 8 3/4"

WFE-074-009
25.0 cm / 10"

WFE-074-010
28.0 cm / 11"



WORTH FIELD
ENTERPRISES

General Instruments Artery Forceps, Bronchus & Gall Duct Clamps



McQuigg-Mixter
WFE-075-011
22.0 cm / 8 3/4"



1/1



Lower
WFE-075-012
18.0 cm / 7"



1/1



Lahey
WFE-075-013-WFE-075-014



1/1

WFE-075-013
19.0 cm / 7 1/2"

1/1

WFE-075-014
23.0 cm / 9"



Finocchietto
WFE-075-015
24.0 cm / 9 1/2"

1/1





Guyon
WFE-076-001-WFE-076-002



WFE-076-001
23.0 cm / 9"



WFE-076-0012
24.0 cm / 9½"



General Instruments Kidney Pedicle Clamp Forceps

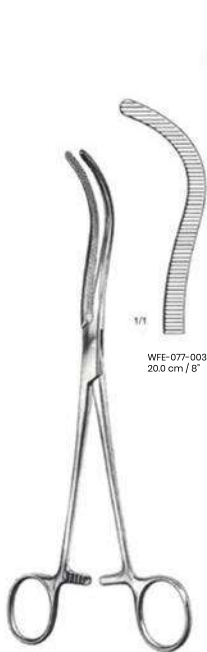

WFE-077-003
20.0 cm / 8"

Guyon
WFE-077-003-WFE-077-005



WFE-077-004
22.0 cm / 8 3/4"



WFE-077-005
24.0 cm / 9 1/2"



Guyon
WFE-077-006
23.0 cm / 9"





Desjardins
WFE-078-007
21.0 cm / 8 1/4"



Negus
WFE-078-008-WFE-078-009
19.0 cm / 7 1/2"



WFE-078-008



WFE-078-009



General Instruments Clamp-Forceps, Hysterectomy & Vaginal Forceps



Phaneuf
WFE-079-001-WFE-079-002
21.5 cm / 8 1/2"
1x2 Teeth



WFE-079-001



WFE-079-002



Heaney
WFE-079-003-WFE-079-008



WFE-079-003
19.5 cm / 7 3/4"



WFE-079-004
21.0 cm / 8 1/4"



WFE-079-005
23.0 cm / 9"



WFE-079-006
19.5 cm / 7 3/4"



WFE-079-007
21.0 cm / 8 1/4"



WFE-079-008
23.0 cm / 9"





Wertholl-Cullen
WFE-080-001
21.5 cm / 8½"



Wertheil
WFE-080-002
24.0 cm / 9½"

Extra Strong



General Instruments Clamp-Forceps, Hysterectomy & Vaginal Forceps



Faure
WFE-081-003
25.0 cm / 10"



Wertheim
WFE-081-004
25.0 cm / 10"
heavy pattern



Wertheim
WFE-081-005
25.0 cm / 10"



General Instruments Clamp-Forceps, Hysterectomy & Vaginal Forceps

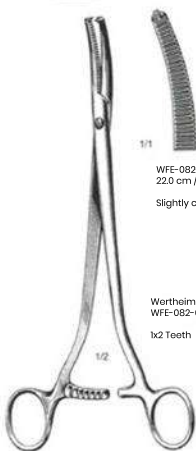

WFE-082-006
22.0 cm / 8 3/4"

Slightly curved

WFE-082-006
23.0 cm / 8"

More curved

Wertheim
WFE-082-006-WFE-082-007
1x2 Teeth



WFE-082-008
22.0 cm / 8 3/4"

Slightly curved

WFE-082-009
23.0 cm / 8"

More curved

Wertheim
WFE-082-008-WFE-082-009
1x2 Teeth

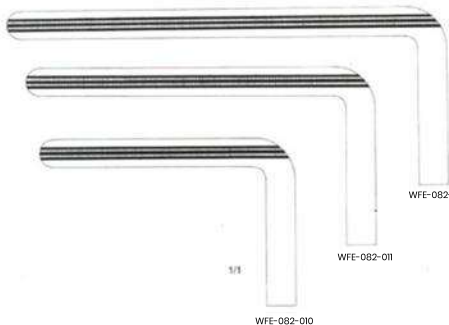

1/1

WFE-082-010

WFE-082-011

WFE-082-012

Wertheim
WFE-082-010-WFE-082-01012
24.0 cm / 9 1/2"

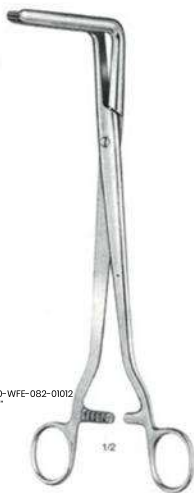

1/2



WORTH FIELD
ENTERPRISES



1/2

Schaedel
WFE-083-001
9.0 cm / 3½"



1/2

WFE-083-002-5.0 cm / 2"
WFE-083-003-9.0 cm / 3½"



WFE-083-004-11.0 cm / 4½"
WFE-083-005-13.0 cm / 5"

Delicate Pattern

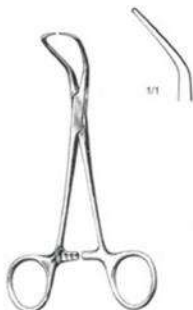

1/1

Backhaus
WFE-083-006-11.0 cm / 3½"
WFE-083-007-13.0 cm / 4½"
WFE-083-008-13.0 cm / 5"
WFE-083-009-15.0 cm / 6"



Roeder
WFE-083-010-13.0 cm / 5"
WFE-083-011-15.0 cm / 6"

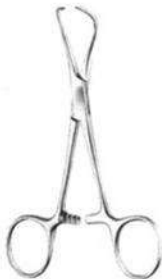

1/1

Lorna
WFE-083-010-10.0 cm / 4"
WFE-083-013-13.0 cm / 5"





Standard
WFE-084-001-WFE-084-003



WFE-084-001
15.0 cm / 6"



WFE-084-002
18.0 cm / 7"



V-084-003
20.0 cm / 8"

1/2



WFE-084-004-WFE-084-0006

• with safety guard



WFE-084-004
15.0 cm / 6"



WFE-084-005
18.0 cm / 7"



WFE-084-006
20.0 cm / 8"

1/2





Petit-Point Jacobson Mosquito Forceps
WFE-085-001 - 13.0 cm / 5" - Straight
WFE-085-002 - 13.0 cm / 5" - Curved

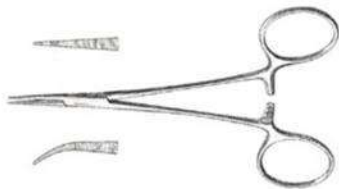

Petit-Point Jacobson Mosquito Forceps
WFE-085-003 - 9.8 cm / 3 7/8" - Straight
WFE-085-004 - 9.8 cm / 3 7/8" - Curved
WFE-085-005 - 9.8 cm / 4 1/8" - Straight
WFE-085-006 - 9.8 cm / 4 1/8" - Curved

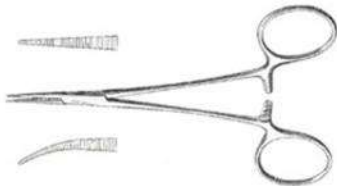

Petit-Point Mosquito Forceps
WFE-085-007 - 15.0 cm / 6" - Straight
WFE-085-008 - 15.0 cm / 6" - Curved

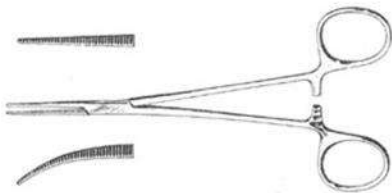



Petit-Point Mosquito Forceps
WFE-086-009 - 18.1 cm / 7 $\frac{1}{8}$ " - Straight
WFE-086-010 - 18.1 cm / 7 $\frac{1}{8}$ " - Curved

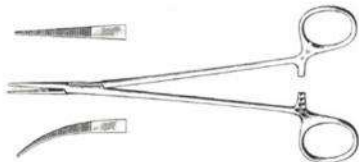

Petit-Point Crile Forceps
WFE-086-011 - 14.0 cm / 5 $\frac{1}{2}$ " - Straight
WFE-086-012 - 14.0 cm / 5 $\frac{1}{2}$ " - Curved

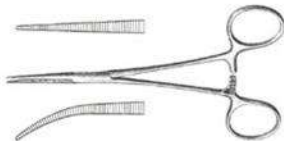

Petit-Point Pean Forceps
WFE-086-013 - 14.0 cm / 5 $\frac{1}{2}$ " - Straight
WFE-086-014 - 14.0 cm / 5 $\frac{1}{2}$ " - Curved

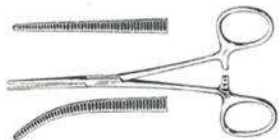

Petit-Point Pean Ochsner Forceps
WFE-086-015 - 14.0 cm / 5 $\frac{1}{2}$ " - Straight
WFE-086-016 - 14.0 cm / 5 $\frac{1}{2}$ " - Curved

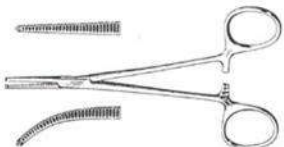

General Instruments Artery Forceps & Scissors



Petit-Point Reynolds Scissors
WFE-087-017 - 13.0 cm / 5" - Curved
CARB-EDGE blades,
one blade serrated



Petit-Point Olsen-Hegar Needle Holder
13.0 cm / 5" - delicate

WFE-087-018 Serrated
WFE-087-019 Smooth

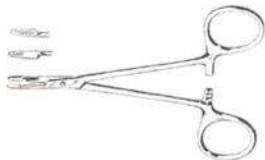

Petit-Point Olsen-Hegar Needle Holder
13.0 cm / 5" - delicate CARB-BITE jaws

WFE-087-020 Serrated
WFE-087-021 Smooth



Petit-Point Ryder Needle Holder
Imm CARB-BITE jaws, serrated

WFE-087-022 13.0 cm / 5"
WFE-087-023 15.0 cm / 6"
WFE-087-024 18.0 cm / 7"
WFE-087-025 23.0 cm / 9"





Petit-Point Ryder Needle Holders
Imm CARB-BITE jaws, smooth

WFE-088-026 12.7 cm / 5"
WFE-088-027 15.0 cm / 6"
WFE-088-028 18.0 cm / 7"
WFE-088-029 23.0 cm / 9"

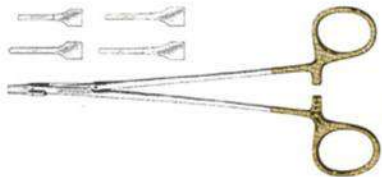

Petit-Point Sarot Needle Holders
Imm CARB-BITE jaws, delicate

WFE-088-030 15.0 cm / 6"
WFE-088-031 16.8 cm / 6½"

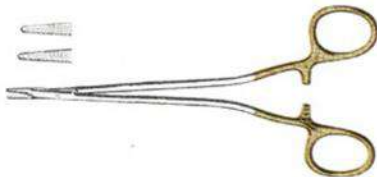

Petit-Point Allis Tissue Holders

WFE-088-032 13.3 cm / 5¼"
3x4 Teeth

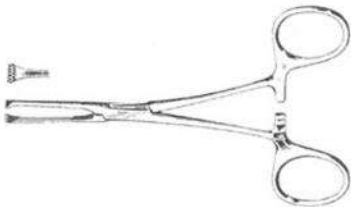



Petit-Point Babcock Forceps

WFE-089-033 13.3 cm / 5 $\frac{1}{2}$ " jaws width 6mm
WFE-089-034 16.0 cm / 6 $\frac{1}{2}$ " jaws width 7.5mm

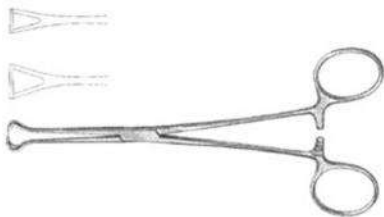

Petit-Point Mixer Forceps

WFE-089-035 13.3 cm / 5 $\frac{1}{2}$ "

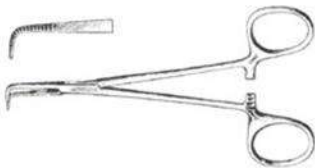

Petit-Point Mixer Forceps

WFE-089-036 18.5 cm / 7 $\frac{1}{2}$ "

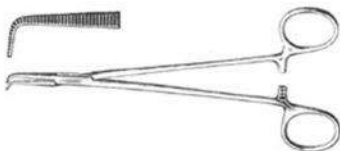

General Instruments Dressing & Cotton Swab Forceps Foreign Body Forceps



1/1

WFE-090-001 - 20.0 cm / 8"
WFE-090-002 - 25.0 cm / 10"

without ratchet

Gross-Maier
WFE-090-001-WFE-090-004



WFE-090-003 - 20.0 cm / 8"
WFE-090-004 - 25.0 cm / 10"



1/1

WFE-090-005 - 20.0 cm / 8"
WFE-090-006 - 25.0 cm / 10"

with ratchet

Gross-Maier
WFE-090-005-WFE-090-008



WFE-090-007 - 20.0 cm / 8"
WFE-090-008 - 25.0 cm / 10"



Gross-Maier
WFE-090-009-WFE-090-018

1/1

WFE-090-009- 20.0 cm / 8"
WFE-090-010- 22.0 cm / 8 3/4"
WFE-090-011- 25.0 cm / 10"
WFE-090-012- 27.0 cm / 10 1/2"



WFE-090-013- 20.0 cm / 8"
WFE-090-014- 22.0 cm / 8 3/4"
WFE-090-015- 25.0 cm / 10"
WFE-090-016- 27.0 cm / 10 1/2"



General Instruments
Polypus & Dressing Forceps
Cotton Swab Forceps



Cheron
WFE-091-017
25.0 cm / 10"

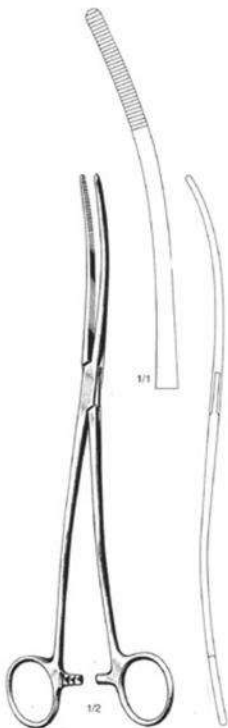

Bozemann
WFE-091-018
26.0 cm / 10 1/4"

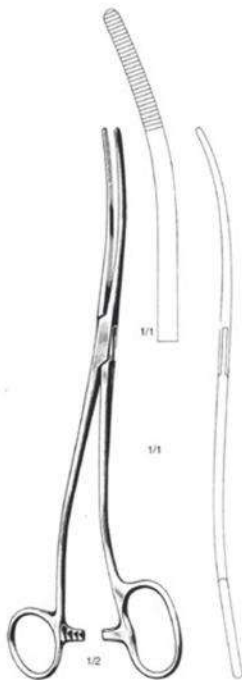

Bozemann-Douglass
WFE-091-019
26.0 cm / 10 1/4"



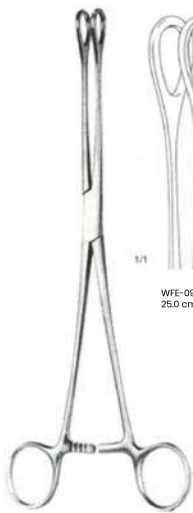

Foerster
WFE-092-020 - WFE-092-027



WFE-092-020
25.0 cm / 10"



WFE-092-021 - 18.0 cm / 7"
WFE-092-022 - 20.0 cm / 8"
WFE-092-023 - 25.0 cm / 10"

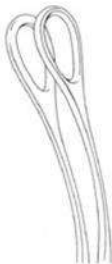

WFE-092-024
25.0 cm / 10"



WFE-092-025 - 18.0 cm / 7"
WFE-092-026 - 20.0 cm / 8"
WFE-092-027 - 25.0 cm / 10"





Foester
WFE-093-028 - WFE-093-029
25.0 cm / 10"



WFE-093-028



WFE-093-029



Ramley
WFE-093-030
25.0 cm / 10"





1/2

WFE-094-001-WFE-094-002
18.0 cm / 7"



1/2

WFE-094-003-WFE-094-004
18.0 cm / 7"



Barraquer
WFE-094-005
18.0 cm / 6 3/4"



Barraquer
WFE-094-006
14.0 cm / 5 1/2"



Kalt
WFE-094-007
14.0 cm / 5 1/2"



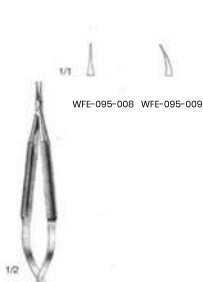

WFE-095-008 WFE-095-009

Barraquer-Trounman
WFE-095-008-WFE-095-009
10.0 cm / 4"

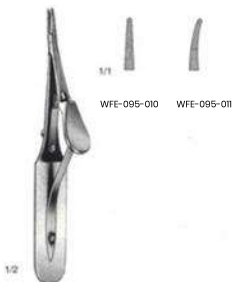

WFE-095-010 WFE-095-011

Arruga
WFE-095-010-WFE-095-011
14.0 cm / 5 1/2"

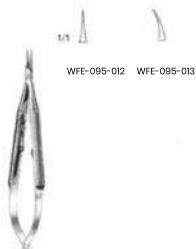

WFE-095-012 WFE-095-013

Barraquer-Trounman
WFE-095-013-WFE-095-013
10.0 cm / 4"

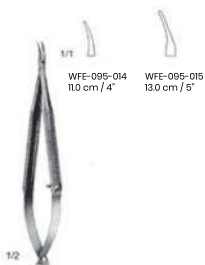

WFE-095-014 WFE-095-015
11.0 cm / 4" 13.0 cm / 5"

Barraquer
WFE-095-014-WFE-095-015



Barraquer
WFE-095-016
14.0 cm / 5 1/2"



WFE-095-017
13.0 cm / 5"





1/1



WFE-096-018



WFE-096-019



1/2

Castroviejo
WFE-096-018-WFE-096-019
9.0 cm / 3½"

1/1



WFE-096-020



WFE-096-021



1/2

Castroviejo
WFE-096-020-WFE-096-021
9.0 cm / 3½"

1/1



WFE-096-022



WFE-096-023



1/2

Castroviejo
WFE-096-022-WFE-096-023
14.0 cm / 5½"

1/1



WFE-096-024



WFE-096-025



1/2

Castroviejo
WFE-096-024-WFE-096-025
14.0 cm / 5½"





WFE-097-026

WFE-097-027

1/2

Castroviejo
WFE-097-026-WI-097-027
14.0 cm / 5 1/2"

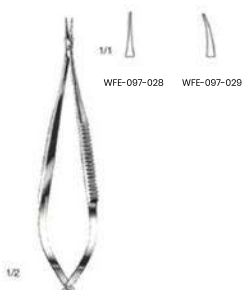

WFE-097-028

WFE-097-029

1/2

Castroviejo
WFE-097-028-WFE-097-029
14.0 cm / 5 1/2"

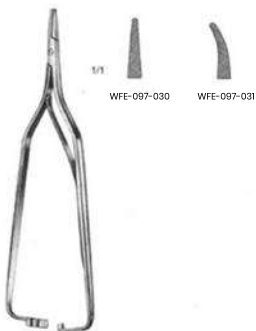

WFE-097-030

WFE-097-031

Castroviejo
WFE-097-030-WFE-097-031
16.0 cm / 6 1/4"



Castroviejo
WFE-097-032
13.0 cm / 5 1/4"

Castroviejo-Barraquer
WFE-097-033
12.0 cm / 4 3/4"



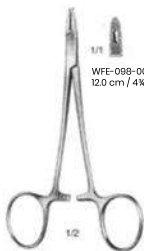

WFE-098-001
12.0 cm / 4"



WFE-098-002
12.5 cm / 5"



Collier
WFE-098-003
12.5 cm / 2"



Webster
WFE-098-004
13.0 cm / 5"

Smooth Jaws

Smooth Jaws, with special groove

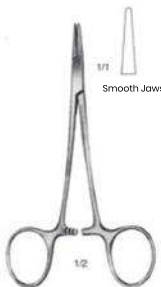

Haisey
WFE-098-005
13.0 cm / 5"

Smooth Jaws



Neivert
WFE-098-006
13.0 cm / 5"



Hegar-Baumgartner
WFE-098-007
14.0 cm / 5 1/2"



Brown
WFE-098-008 - 13.0 cm / 5"
WFE-098-009 - 18.0 cm / 7"

WFE-098-008 WFE-098-009





Crile-Murray
WFE-099-010
15.0 cm / 6"



Crile-Wood
WFE-099-011
15.0 cm / 6"



Adson
WFE-099-012
18.0 cm / 7"



Metzenbaum
WFE-099-013
18.0 cm / 7"



M.G.H. (Mass-General-Hospital)
WFE-099-014
17.0 cm / 6 3/4"

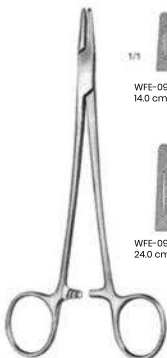

Mayo-Hegar
WFE-099-015-WFE-099-021



WFE-099-015
14.0 cm / 5 1/2"



WFE-099-016
16.0 cm / 6 3/4"



WFE-099-017
18.0 cm / 7"



WFE-099-018
20.0 cm / 8"



WFE-099-019
24.0 cm / 9 1/2"



WFE-099-020
26.0 cm / 10 1/4"



WFE-099-021
30.0 cm / 12"





Mayo-Hegar
WFE-100-022-WI-100-024

1/3



WFE-100-022
16.0 cm / 6 1/4"



WFE-100-023
18.0 cm / 7"



WFE-100-024
20.0 cm / 8"

delicate pattern



Jamison
WFE-100-025
23.5 cm / 9 1/4"

1/1

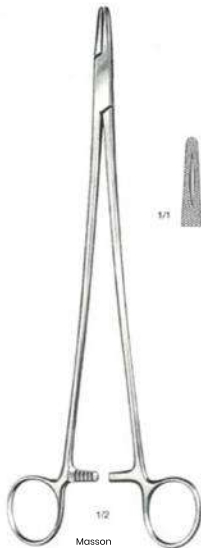

Masson
WFE-100-026
27.0 cm / 10 5/8"

1/1





Finocchioletto
WFE-101-027
27.0 cm / 10½"



Wangenstoen
WFE-101-028
27.0 cm / 10½"



Johnson
WFE-101-029
27.0 cm / 10½"



Suture Needles Holders



Stratte
WFE-102-030
23.0 cm / 9"



Olsen-Hegar
WFE-102-031
17.0 cm / 6 1/4"



Olsen-Hegar
WFE-102-032-WFE-102-033

WFE-102-032
14.0 cm / 4 1/2"

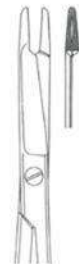

WFE-102-033
18.0 cm / 7"

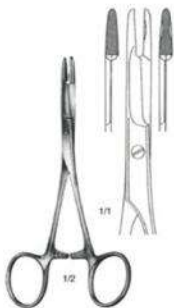

Olsen-Hegar
WFE-102-034
14.0 cm / 5 1/2"



Gillies
WFE-102-035
16.0 cm / 6 1/4"



Crile
WFE-102-036
15.0 cm / 6"



Suture Needles Holders



Mathieu
WFE-103-037-WFE-103-039



WFE-103-037 14.0 cm / 5½"
WFE-103-038 17.0 cm / 6¾"
WFE-103-039 20.0 cm / 8"



Mathieu
WFE-103-030-WFE-103-041



WFE-103-040 14.0 cm / 5½"
WFE-103-041 17.0 cm / 6¾"

Slender jaws



Mathieu
WFE-103-042-WFE-103-043



WFE-103-042 17.0 cm / 6¾"
WFE-103-043 20.0 cm / 8"



Toennis
WFE-103-044
18.0 cm / 7"



Lichtenberg
WFE-103-045
20.0 cm / 8"



Suture Reverdin Needles



1/2

Reverdin
WFE-104-001-WFE-104-004
14.0 cm / 5 1/2"

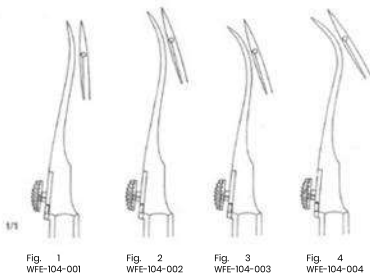

Fig. 1
WFE-104-001

Fig. 2
WFE-104-002

Fig. 3
WFE-104-003

Fig. 4
WFE-104-004



1/2

Reverdin
WFE-104-005-WFE-104-008
22.5 cm / 8 7/8"

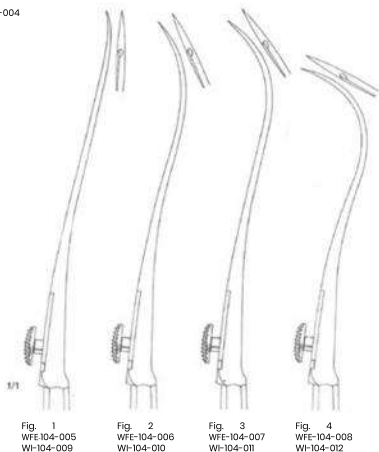

Fig. 1
WFE-104-005
WI-104-009

Fig. 2
WFE-104-006
WI-104-010

Fig. 3
WFE-104-007
WI-104-011

Fig. 4
WFE-104-008
WI-104-012



1/2

Reverdin
WFE-104-009-WFE-104-012
19.5 cm / 7 3/4"



Suture Ligature Needles

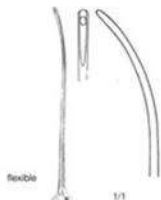

flexible

1/1

1/2

WI-105-013
20.0 cm / 8"



1/1

1/2

Cooper
WI-105-014
19.0 cm / 7 1/2"

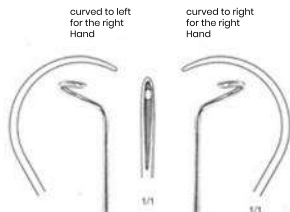

curved to left
for the right
Hand

curved to right
for the right
Hand

1/1

1/1

1/2

1/2

Deschamps
WI-105-017
24.0 cm / 9 1/2"

Deschamps
WI-105-018
24.0 cm / 9 1/2"



1/2

1/1

Kronecker
WI-105-015
13.0 cm / 5"

Kronecker
WI-105-016
13.0 cm / 5"



WORTH FIELD
ENTERPRISES

General Instruments Scissors With Tungsten Carbide Inserts



GOLD PLATED



Standard
WFE-106-001-WFE-106-003



WFE-106-001
14.5 cm / 5 7/8"



WFE-106-002
16.5 cm / 6 1/2"



WFE-106-003
18.5 cm / 7 1/4"



Standard
WFE-106-004-WFE-106-006



WFE-106-004
14.5 cm / 5 7/8"

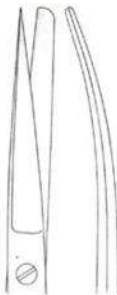

WFE-106-005
16.5 cm / 6 1/2"

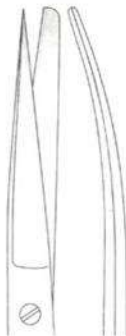

WFE-106-006
18.5 cm / 7 1/4"



General Instruments Scissors With Tungsten Carbide Inserts



GOLD PLATED



Standard
WFE-106-007-WFE-106-009

1/1



WFE-106-007
14.5 cm / 5"

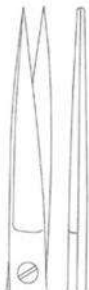

WFE-106-008
16.5 cm / 6 1/2"

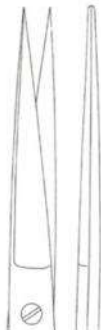

WFE-106-009
18.5 cm / 7 1/4"



Standard
WFE-106-004-WFE-106-006

1/1



WFE-106-004
14.5 cm / 5"



WFE-106-005
16.5 cm / 6 1/2"

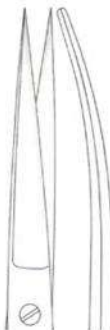

WFE-106-006
18.5 cm / 7 1/4"



General Instruments Scissors With Tungsten Carbide Inserts



GOLD PLATED



Mayo
WFE-108-001-WFE-108-003

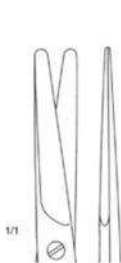

WFE-108-001
14.5 cm / 5 3/4"

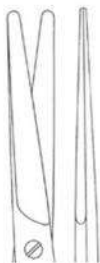

WFE-108-002
17.0 cm / 6 3/4"

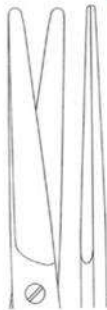

WFE-108-003
23.0 cm / 9"



Mayo
WFE-108-004-WFE-108-006



WFE-108-004
14.5 cm / 5 3/4"



WFE-108-005
17.0 cm / 6 3/4"



WFE-108-006
23.0 cm / 9"



General Instruments Scissors With Tungsten Carbide Inserts



GOLD PLATED



WFE-109-007-WFE-109-009



WFE-109-007
14.0 cm / 5 1/2"



WFE-109-008
17.0 cm / 7"



WFE-109-009
23.0 cm / 9"



WORTH FIELD
ENTERPRISES

General Instruments Scissors With Tungsten Carbide Inserts



GOLD PLATED



Mayo-Style
WFE-110-010-WFE-110-011

1/1



WFE-110-010
15.0 cm / 6"



WFE-110-011
17.0 cm / 7"



Mayo-Style
WFE-110-012-WFE-110-013

1/1

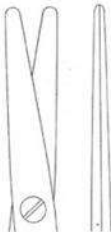

WFE-110-012
15.0 cm / 6"

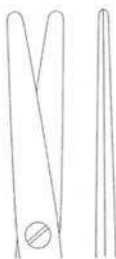

WFE-110-013
17.0 cm / 7"



WORTH FIELD
ENTERPRISES

General Instruments Scissors With Tungsten Carbide Inserts



GOLD PLATED



Metzenbaum
WFE-III-001-WFE-III-002



WFE-III-001
11.5 cm / 4 1/2"



WFE-III-002
14.5 cm / 5 3/4"



Metzenbaum
WFE-III-003-WFE-III-004

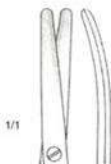

WFE-III-003
11.5 cm / 4 1/2"



WFE-III-004
14.5 cm / 5 3/4"



General Instruments Scissors With Tungsten Carbide Inserts



GOLD PLATED



WFE-112-005
18.0 cm / 7"



WFE-112-006
20.0 cm / 8"

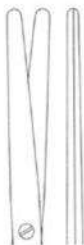

WFE-112-007
23.0 cm / 9"



Metzenbaum
WFE-112-005-WFE-112-010

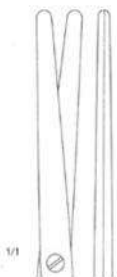

WFE-112-008
25.0 cm / 10"

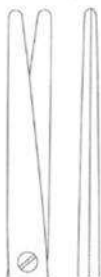

WFE-112-009
28.0 cm / 11"

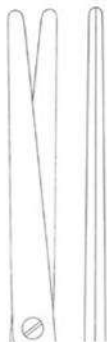

WFE-112-012
30.0 cm / 12"



WORTH FIELD
ENTERPRISES

General Instruments Scissors With Tungsten Carbide Inserts



GOLD PLATED



WFE-113-011
18.0 cm / 7"



WFE-113-012
20.0 cm / 8"



WFE-113-013
23.0 cm / 9"



Metzenbaum
WFE-113-011-WFE-113-016



WFE-113-014
25.0 cm / 10"



WFE-113-015
28.0 cm / 11"



WFE-113-016
30.0 cm / 12"



WORTH FIELD
ENTERPRISES

General Instruments Scissors With Tungsten Carbide Inserts



GOLD PLATED



Metzenbaum-Lahey
WFE-114-017
14.0 cm / 5½"



Toennis-Adson
WFE-114-018
17.0 cm / 7"

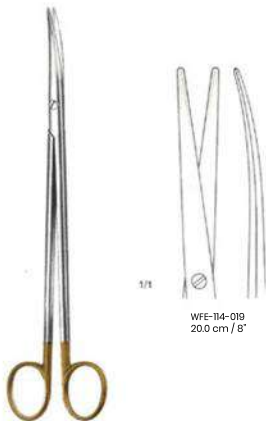

Metzenbaum
WFE-114-019-WFE-114-020

WFE-114-019
20.0 cm / 8"

WFE-114-020
23.0 cm / 9"



General Instruments Scissors With Tungsten Carbide Inserts



GOLD PLATED

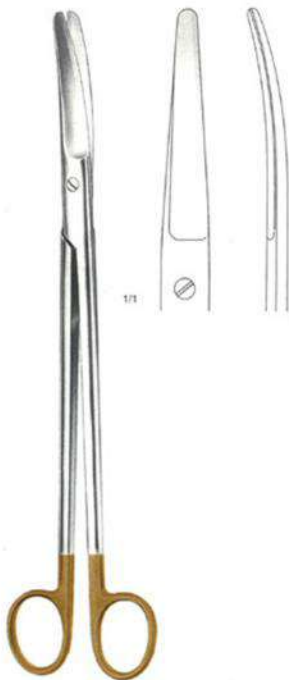

Mayo-Harrington
WFE-115-021
28.0 cm / 11"

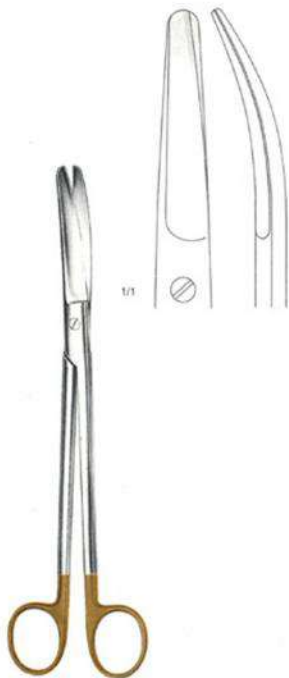

Sims
WFE-115-022
23.0 cm / 9"



General Instruments Scissors With Tungsten Carbide Inserts



GOLD PLATED



WFE-116-001
13.0 cm / 5"

WFE-116-002
13.0 cm / 5"

WFE-116-003
11.5 cm / 4 1/2"

WFE-116-004
11.5 cm / 4 1/2"



WFE-116-005
19.0 cm / 7 1/2"
25°

WFE-116-006
19.0 cm / 7 1/2"
45°

WFE-116-007
19.0 cm / 7 1/2"
60°

De Bakey
(Potts-Smith)
WFE-116-005-WFE-116-010

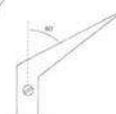

WFE-116-008
19.5 cm / 7 3/4"
25°

WFE-116-009
19.5 cm / 7 3/4"
45°

WFE-116-010
23.0 cm / 9"
60°



General Instruments Supercut Scissors - General Surgery



Mayo Scissors

WFE-117-001 - 14.0 cm / 5½" straight

WFE-117-002 - 14.0 cm / 5½" curved

WFE-117-003 - 17.0 cm / 6¾" straight

WFE-117-004 - 17.0 cm / 6¾" curved

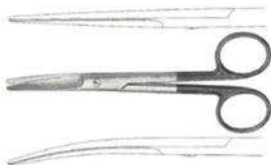

Mayo Scissors

WFE-117-005 - 23.0 cm / 9" straight

WFE-117-006 - 23.0 cm / 9" curved

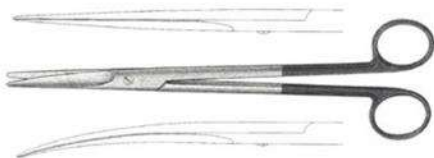

Metzenbaum (Lahey)

WFE-117-007 - 14.6 cm / 5¾" straight

WFE-117-008 - 14.6 cm / 5¾" curved



Metzenbaum

WFE-117-009 - 18.0 cm / 7" curved

WFE-117-010 - 23.0 cm / 9" curved



Iris Scissors

WFE-117-011 - 11.5 cm / 4½" straight

WFE-117-012 - 11.5 cm / 4½" curved





Knight Nasal Scissors
WFE-118-013 - 17.0 cm / 6 3/4"

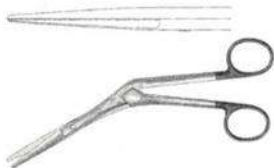

Plastic Surgery Scissors
WFE-118-014 - 12.0 cm / 4 3/4" straight
WFE-118-015 - 12.0 cm / 4 3/4" curved

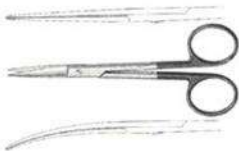

Castanares Face Lift Scissors
WFE-118-016 - 16.0 cm / 6 1/4" straight



Gorney
WFE-118-017 - 18.5 cm / 7 1/4" straight
WFE-118-018 - 18.5 cm / 7 1/4" curved

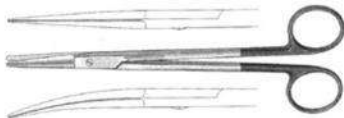

General Instruments Supercut Scissors Plastic and Reconstructive



Kaye Face Lift Scissors
beveled blades have semi-sharp outer edges

WFE-119-019 - 15.0 cm / 6" curved
WFE-119-020 - 19.0 cm / 7½" curved

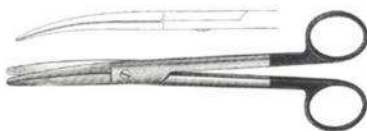

Freeman-Gorney Face Lift Scissors
beveled blades have semi-sharp outer edges
and flat, tapered tips:

WFE-119-021 - 15.0 cm / 6" curved
WFE-119-022 - 19.0 cm / 7½" curved

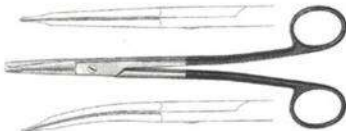

Freeman-Kaye Face Lift Scissors
beveled blades have semi-sharp outer edges
and flat, tapered tips:

WFE-119-023 - 18.0 cm / 7" curved
WFE-119-024 - 18.0 cm / 7" curved

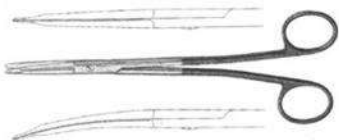

Freeman Rhytidectomy Scissors
WFE-119-025 - 18.0 cm / 7" curved with flat tips



Gorney Platysma Scissors
beveled blades have semi-sharp
outer edges and flat, tapered tips:

WFE-119-026 - 23.0 cm / 9" straight
WFE-119-027 - 23.0 cm / 9" curved

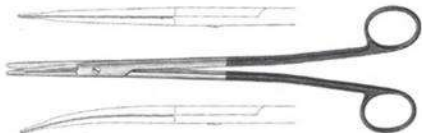

General Instruments Supercut Scissors Plastic and Reconstructive



Formon Lateral Scissors,
WFE-120-028 - 13.0 cm / 5" full curved

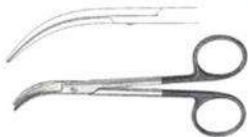

Formon Lateral Scissors,
WFE-120-029 - 14.6 cm / 5 7/8" angled on flat



Cattle Dorsal Scissors,
WFE-120-030 - 16.5 cm / 6 1/2" angled on flat



Plastic and Reconstructive Scissors
WFE-120-031 - 11.4 cm / 4 1/2" curved
WFE-120-032 - 14.6 cm / 5 7/8" curved



Petit-point Reynolds Scissors
WFE-120-033 - 13.0 cm / 5" curved

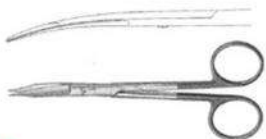

General Instruments Supercut Scissors Cardiovascular



Jamison Scissors

WFE-121-034 - 14.0 cm / 5½" curved
WFE-121-035 - 18.0 cm / 7" curved



Metzenbaum Scissors

WFE-121-036 - 18.0 cm / 7" curved, delicate

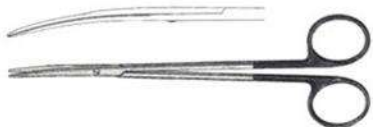

Endarterectomy Scissors

WFE-121-037 - 17.0 cm / 6¾" curved



General Instruments Supercut Scissors Cardiovascular



Potte-Smith Scissors

WFE-122-038 - 18.0 cm / 7" 25°
WFE-122-039 - 18.0 cm / 7" 45°
WFE-122-040 - 18.0 cm / 7" 60°



Diethrich Coronary Artery Scissors

WFE-122-041 - 18.0 cm / 7" 25°
WFE-122-042 - 18.0 cm / 7" 45°
W-122-043 - 18.0 cm / 7" 60°
WFE-122-044 - 18.0 cm / 7" 90°
WFE-122-045 - 18.0 cm / 7" 125°



Diethrich Coronary Artery Scissors

WFE-122-041 - 18.0 cm / 7" 130°

shanks are stabilized
to keep blades in alignment

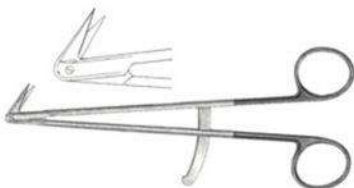

General Instruments Supercut Scissors Cardiovascular



GOLD PLATED



1/2
Ferris-Smith
WFE-123-001
17.0 cm / 6 3/4"
Normal Profile

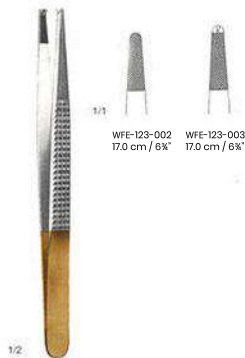

1/2
Bonney
WFE-123-002-WFE-123-003
Normal Profile

WFE-123-002
17.0 cm / 6 3/4"

WFE-123-003
17.0 cm / 6 3/4"



1/2
Gerald
WFE-123-004-WFE-123-005

WFE-123-004
17.0 cm / 6 3/4"

WFE-123-005
17.0 cm / 6 3/4"

Micro Profile

Micro Profile



1/2
Gillies
WFE-123-006
15.0 cm / 6"
Mini profile



1/2
Mc Indoe
WFE-123-007
15.0 cm / 6"
Mini profile

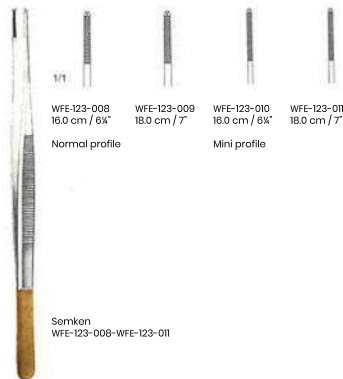

1/1
WFE-123-008
16.0 cm / 6 1/4"

WFE-123-009
18.0 cm / 7"

WFE-123-010
16.0 cm / 6 1/4"

WFE-123-011
18.0 cm / 7"

Normal profile

Mini profile

Semken
WFE-123-008-WFE-123-011



General Instruments Dessecting Forceps Tungsten Carbide Inserts



GOLD PLATED



Adson-Brown
WFE-124-012
12.0 cm / 4 3/4"

Normal profile



WFE-124-013 12.0 cm / 4 3/4"
WFE-124-014 15.0 cm / 6"

Micro-Adson
WFE-124-013-WFE-124-014

Mini profile



WFE-124-015 12.0 cm / 4 3/4"
WFE-124-018 12.0 cm / 4 3/4"
WFE-124-017 15.0 cm / 6"
WFE-124-018 15.0 cm / 6"

Adson
WFE-124-015-WFE-124-018

Normal profile



with dissector end

Cushing
WFE-124-019
17.5 cm / 7"

Normal profile



with dissector end

Cushing
WFE-124-020
18.0 cm / 7"

Normal profile



Cushing-Taylor
WFE-124-021
18.0 cm / 7"

Normal profile



General Instruments Dessecting Forceps, Tungsten Carbide Inserts



GOLD PLATED



1/1

WFE-125-022
15.0 cm / 6"

WFE-125-023
18.0 cm / 7"

WFE-125-024
20.0 cm / 8"

WFE-125-025
23.0 cm / 9"

WFE-125-026
25.0 cm / 10"

Normal profile

Potts-Smith
WFE-125-022-WFE-125-026



1/1

WFE-125-027
14.0 cm / 5 1/2"

WFE-125-028
16.0 cm / 6"

WFE-125-029
18.0 cm / 7"

WFE-125-030
20.0 cm / 8"

WFE-125-031
25.0 cm / 10"

WFE-125-032
30.0 cm / 12"

Normal profile

Oehler
WFE-125-027-WFE-125-032



WORTH FIELD
ENTERPRISES

General Instruments Dessecting Forceps, Tungsten Carbide Inserts



GOLD PLATED

Micro profile

Mini profile



1/1

WFE-126-033
15.0 cm / 6"

WFE-126-034
19.0 cm / 7½"

WFE-126-035
24.0 cm / 9½"



WFE-126-036
15.0 cm / 6"

WFE-126-037
19.0 cm / 7½"

WFE-126-038
24.0 cm / 9½"

De Bakay
WFE-126-033-WFE-126-038

1/1



WFE-126-040
15.0 cm / 6"

WFE-126-041
23.0 cm / 9"

WFE-126-042
25.0 cm / 10"



WFE-126-039
15.0 cm / 6"

Smooth



Wangensteen
WFE-126-040-WFE-126-042

Normal profile



WORTH FIELD
ENTERPRISES

Sature Needle Holders Tungsten Carbide Inserts



GOLD PLATED



1/1				
	WFE-127-001	WFE-127-002	WFE-127-003	WFE-127-004
	with lock	with lock	without lock	without lock

Micro profile

Vascular
WFE-127-001-WFE-127-004
18.0 cm / 7"



1/1					
	WFE-127-005	WFE-127-006	WFE-127-007	WFE-127-008	WFE-127-009
	18.0 cm / 6 3/4"	18.0 cm / 7"	20.0 cm / 8"	23.0 cm / 9"	26.0 cm / 10 1/4"

Micro profile

Dietrich
WFE-127-005-WFE-127-009



WORTH FIELD
ENTERPRISES

Sature Needle Holders Tungsten Carbide Inserts



GOLD PLATED



Castroviejo
WFE-128-010-WFE-128-015

1/1



WI-128-010
14.0 cm / 5½"

smooth



WI-128-011
18.0 cm / 7"

Micro profile



WI-128-012
21.0 cm / 8¼"

Micro profile



WI-128-013
14.0 cm / 5½"

smooth



WI-128-014
18.0 cm / 7"

Micro profile



WI-128-015
21.0 cm / 8¼"

Micro profile



Arruga
WFE-128-016-WFE-128-017
16.0 cm / 6¼"



WFE-128-016



WFE-128-017

Micro profile



Castroviejo
WFE-128-018
13.0 cm / 5"



1/1

smooth



Baraquero
WFE-128-019
13.0 cm / 5"



smooth



Baraquero
WFE-128-020
13.0 cm / 5"



smooth



WORTH FIELD
ENTERPRISES

Sature Needle Holders Tungsten Carbide Inserts



GOLD PLATED

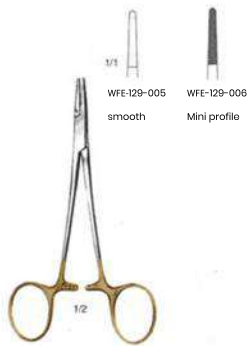

Halsey
WFE-129-005-WFE-129-006
13.0 cm / 5"

Webster
WFE-129-007
12.0 cm / 4 3/4"

Crile-Wood
WFE-129-008
15.0 cm / 6"



Sature Needle Holders Tungsten Carbide Inserts



GOLD PLATED



Sator
WFE-130-009-WFE-130-011

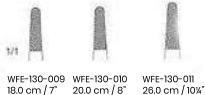

Normal profile

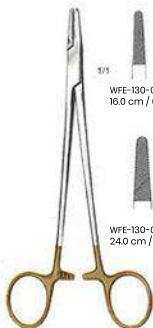

Mayo-Hegar
WFE-130-012-WFE-130-017

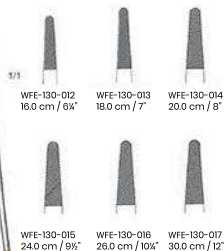

Normal profile

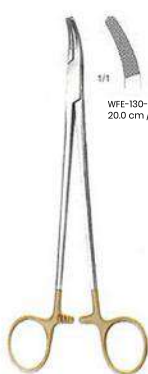

Heaney
WFE-130-018-WFE-130-020

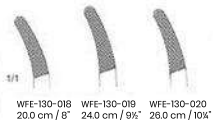

Normal profile



Do Bakay
WFE-130-021-WFE-130-026

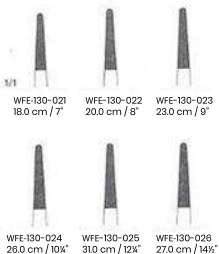

Mini profile



Sature Needle Holders Tungsten Carbide Inserts



GOLD PLATED



Masson
WFE-131-027
27.0 cm / 10 1/2"

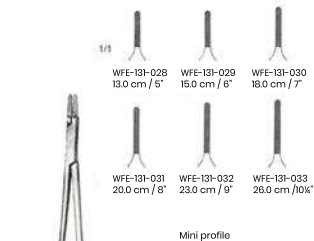

Ryder
WFE-131-028-WFE-131-033

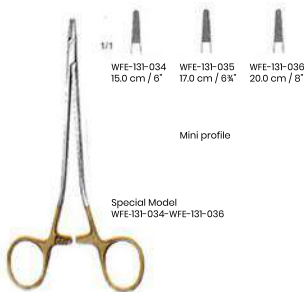

Special Model
WFE-131-034-WFE-131-036



Sature Needle Holders Tungsten Carbide Inserts



GOLD PLATED



Finocchietto
WFE-132-037
27.0 cm / 10 5/8"

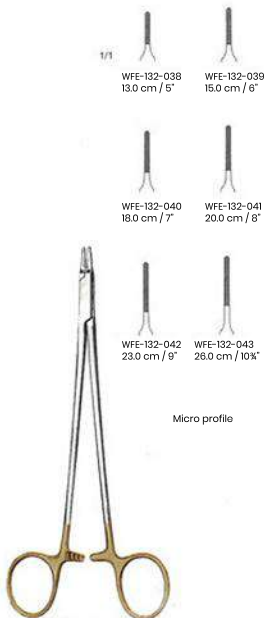

Ryder-Vascular
WFE-132-038-WI-132-043



Wangensteen
WFE-132-044
27.0 cm / 10 5/8"



Suture Needle Holders Tungsten Carbide Inserts



GOLD PLATED



Suture Needle Holders Tungsten Carbide Inserts



GOLD PLATED



WFE-134-054
22.0 cm / 8 1/2"

WFE-134-055
23.0 cm / 9"

Normal profile

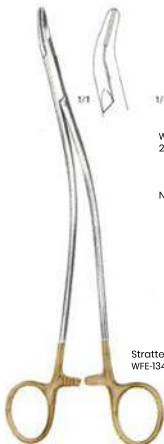

Stratte
WFE-134-054-WFE-134-055

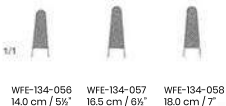

WFE-134-056
14.0 cm / 5 1/2"

WFE-134-057
16.5 cm / 6 1/2"

WFE-134-058
18.0 cm / 7"

Normal profile

Olsen-Hegar
WFE-134-056-WFE-134-058



Gillies
WFE-134-059
16.0 cm / 6 1/4"

Normal profile



Sature Needle Holders Tungsten Carbide Inserts



GOLD PLATED



1/1

WFE-135-060
14.0 cm / 5½"



WFE-135-061
17.0 cm / 6"



WFE-135-062
20.0 cm / 8"

Normal profile

Mathieu-Kocher
WFE-135-060-WFE-135-062



1/1

WFE-135-063
14.0 cm / 5½"



WFE-135-064
17.0 cm / 6"



WFE-135-065
20.0 cm / 8"

Normal profile

Mathieu
WFE-135-063-WFE-135-065



1/1



WFE-135-066
17.0 cm / 6½"



WFE-135-067
20.0 cm / 8"



WFE-135-068
23.0 cm / 9"

Normal profile

Mathieu
WFE-135-066-WFE-135-068



WORTH FIELD
ENTERPRISES

Sature Needle Holders Tungsten Carbide Inserts



GOLD PLATED



1/1

Normal profile

1/2

Toennis
WFE-136-069
18.0 cm / 7"



1/1

Normal profile

1/2

Lichtenberg
WFE-136-070
20.0 cm / 8"

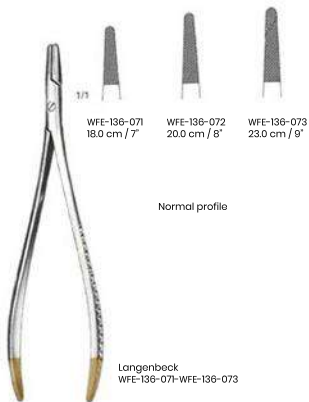

1/3

WFE-136-071
18.0 cm / 7"



WFE-136-072
20.0 cm / 8"



WFE-136-073
23.0 cm / 9"

Normal profile

Langenbeck
WFE-136-071-WFE-136-073

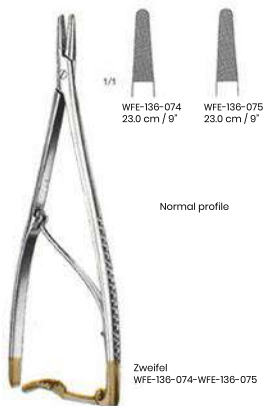

1/1

WFE-136-074
23.0 cm / 9"



WFE-136-075
23.0 cm / 9"

Normal profile

Zwiefel
WFE-136-074-WFE-136-075



WORTH FIELD
ENTERPRISES

Dressing Bandage Scissors



for fingers



Lister
WFE-137-001 - 9.0 cm / 3½"
WFE-137-002 - 14.0 cm / 5½"
WFE-137-003 - 18.0 cm / 7"
WFE-137-004 - 20.0 cm / 8"



Excentric
WFE-137-005 - 16.0 cm / 6¼"
WFE-137-006 - 19.0 cm / 7½"



Knowles
WFE-137-007
14.0 cm / 5½"

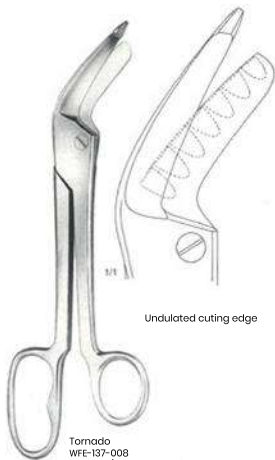

Undulated cutting edge

Tornado
WFE-137-008
24.0 cm / 9½"



Bergmann
WFE-137-009
23.0 cm / 9"



Dressing Clothing Scissors, Plastic Shears

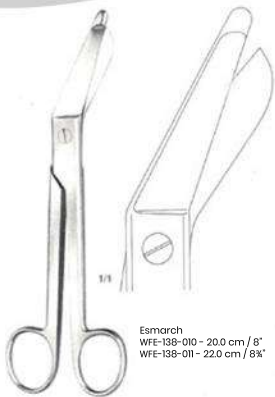

Esmarch
WFE-138-010 - 20.0 cm / 8"
WFE-138-011 - 22.0 cm / 8 3/4"



Lister
WFE-138-012 - 15.0 cm / 6"
WFE-138-013 - 17.0 cm / 7"

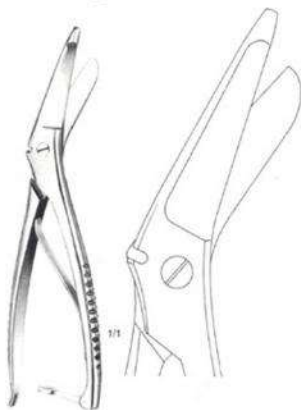

WFE-138-014
20.0 cm / 8"



Bruns
WFE-138-015
24.0 cm / 9 1/2"



Dressing Plaster Sheras, Bandage Scissors



Stile
WFE-139-001-WFE-139-003



WFE-139-001
23.0 cm / 9"

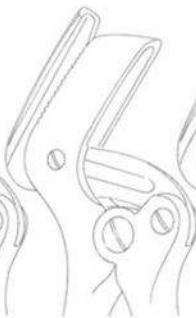

WFE-139-002
26.0 cm / 10 1/4"



WFE-139-003
37.0 cm / 14 1/2"

Tungstan Carbide



Lister
WFE-139-004
18.0 cm / 7"

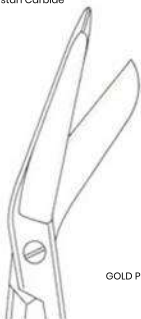

GOLD PLATED

Tungstan Carbide



Bruns
WFE-139-002
21.0 cm / 9 1/2"

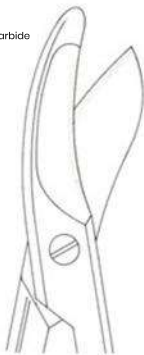

Dressing Plaster Sheras, Bandage Scissors



Engel
WFE-140-006
14.0 cm / 5½"



1/2

Hopkins
WFE-140-007
20.0 cm / 8"



1/2

Hopkins
WFE-140-008
18.0 cm / 87"



1/2

Reiner
WFE-140-009
18.0 cm / 7¼"



1/2

Special Mod. Weldon
WFE-140-010
21.0 cm / 8¼"



Dressing Plaster Sheras, Bandage Scissors



Henning
WFE-141-011
28.0 cm / 11"

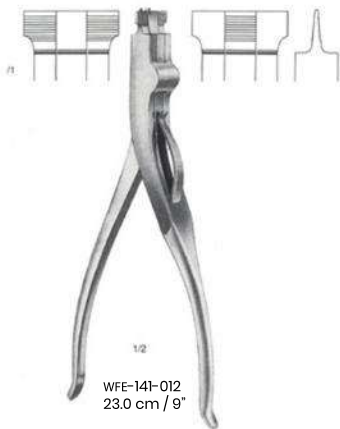

WFE-141-012
23.0 cm / 9"

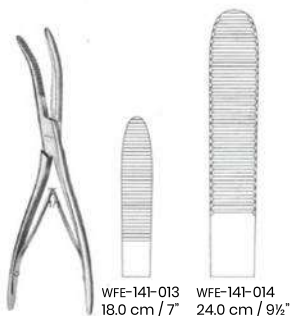

Wolff
WFE-141-013-WFE-141-014



Dressing Plaster Sheras, Bandage Scissors



Cannulated Pin Cutter
WFE-142-001
19.0 cm / 7½". end cutting
maximum capacity .062" (1.6mm)

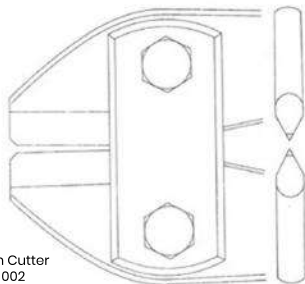
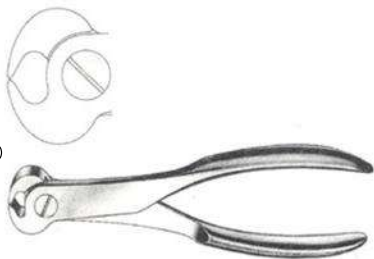

Large Pin Cutter
WFE-142-002
55.6 cm / 22".
cut rods up to .250" (6.3mm).
toggle joint transfers leverage to the cutting blades

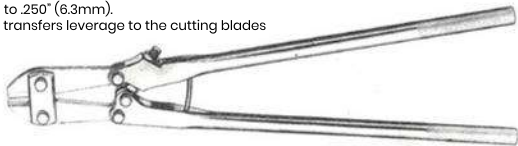

**Dressing
Plaster Sheras, Bandage
Scissors**

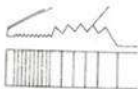

Slip Joint Adjustable Pliers
WFE-143-003
19.7 cm / 7 $\frac{3}{4}$ "

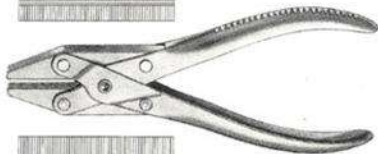

Parallel Pliers
WFE-143-004
18.0 cm / 7" . grooved 10mm wide jaws
for pin removal

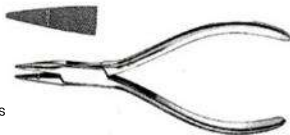

Needle Nose Pliers
WFE-143-005
14.0 cm / 5 $\frac{1}{2}$ " . grooved jaws
tips taper to 1mm



Dressing Plaster Sheras, Bandage Scissors



Flat Nose Pliers,
WFE-144-006
15.0 cm / 6", tips taper to 2mm

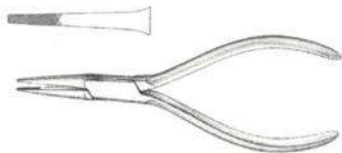

Flat Nose Pliers,
WFE-144-007
16.5 cm / 6½",
tips taper to 3.5mm

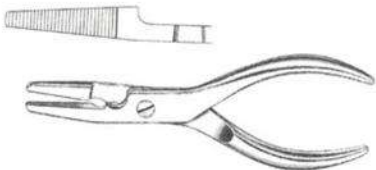

Heavy Duty Locking Pliers,
WFE-144-008
17.0 cm / 6¾", 7mm wide tip
reinforced jaw hinge, self-locking
lever with adjustment screw
and one-handed quick release

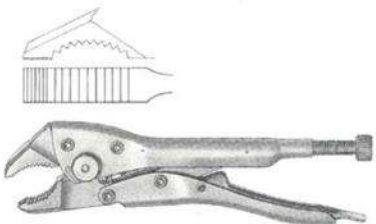

Dressing Plaster Sheras, Bandage Scissors



Heavy Duty Locking Pliers,
WFE-145-009
20.0 cm / 8", 9mm wide tip
reinforced jaw hinge,
self-locking lever with adjustment
screw and one-handed quick release

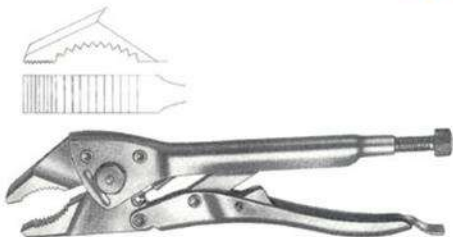

Heavy Duty Locking Pliers,
WFE-145-010
24.0 cm / 9½", 5mm wide tip
reinforced jaw hinge,
self-locking lever with adjustment
screw and one-handed quick release

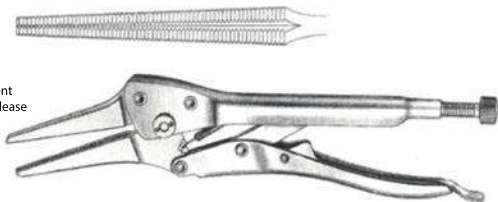

Townley Fermur Caliper,
WFE-145-011
11.5 cm / 4½"



Dressing Plaster Sheras, Bandage Scissors



Buckley
WI-146-001-WI-140-006
16.0 cm / 6¼"



WI-146-001
2mm



WI-146-002
3mm



WI-146-002
4mm



WI-146-004
2mm



WI-146-005
3mm



WI-146-006
4mm



WI-146-007
8mm



WI-146-012
8mm



WI-146-017
8mm



WI-146-008
10mm



WI-146-013
10mm



WI-146-018
10mm



WI-146-009
12mm



WI-146-014
12mm



WI-146-019
12mm



WI-146-010
14mm



WI-146-015
14mm



WI-146-020
14mm



WI-146-011
16mm



WI-14-012-WI-14-016
16mm



WI-14-017-WI-14-021
16mm

WI-146-007-WI-140-011
13.5 cm / 5"

WI-14-012-WI-14-016
13.5 cm / 5¼"

WI-14-017-WI-14-021
13.5 cm / 5¼"



Dressing Plaster Sheras, Bandage Scissors



WFE-147-001
11.0 cm / 1½"



WFE-147-002
11.0 cm / 1½"



WFE-147-003
10.0 cm / 4"



WFE-147-004
10.0 cm / 4"

Buck-Gramcko
WFE-147-001 WFE-147-004



4 mm
WFE-147-025



4 mm
WFE-147-031



2mm WFE-147-005 WFE-147-010
13.5 cm / 5¼" 17.0 cm / 6¾"



2mm WFE-147-015 WFE-147-020
13.5 cm / 5¼" 17.0 cm / 6¾"



6 mm
WFE-147-026



6 mm
WFE-147-032

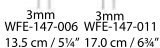

3mm WFE-147-006 WFE-147-011
13.5 cm / 5¼" 17.0 cm / 6¾"

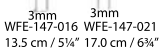

3mm WFE-147-016 WFE-147-021
13.5 cm / 5¼" 17.0 cm / 6¾"



8 mm
WFE-147-027



8 mm
WFE-147-033



4mm WFE-147-007 WFE-147-012
13.5 cm / 5¼" 17.0 cm / 6¾"



4mm WFE-147-017 WFE-147-022
13.5 cm / 5¼" 17.0 cm / 6¾"



10 mm
WFE-147-028



10 mm
WFE-147-034



5mm WFE-147-008 WFE-147-012
13.5 cm / 5¼" 17.0 cm / 6¾"



5mm WFE-147-018 WFE-147-023
13.5 cm / 5¼" 17.0 cm / 6¾"



12 mm
WFE-147-028



12 mm
WFE-147-035



6 mm WFE-147-009 WFE-147-012
13.5 cm / 5¼" 17.0 cm / 6¾"



6 mm WFE-147-019 WFE-147-024
13.5 cm / 5¼" 17.0 cm / 6¾"



14 mm
WI-147-030



14 mm
WFE-147-036

Partsch
WFE-147-005-WFE-147-024

Alexander
WFE-147-025-WFE-147-036
18.0 cm / 7"



WORTH FIELD
ENTERPRISES

Dressing Plaster Sheras, Bandage Scissors



10 mm
WFE-148-001



10 mm
WFE-148-005



10 mm
WFE-148-009



15 mm
WFE-148-003



15 mm
WFE-148-006



15 mm
WFE-148-010



20 mm
WFE-148-004



20 mm
WFE-148-007



20 mm
WFE-148-011



1/1
25 mm
WFE-148-004



1/1
25 mm
WFE-148-008



1/1
25 mm
WFE-148-012



Stille
WFE-148-001-WFE-148-012
20.0 cm / 8"



Dressing Plaster Sheras, Bandage Scissors

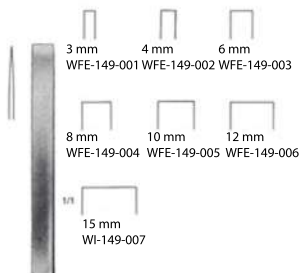

Mini-Lambotte
WFE-149-001-WFE-149-007
12.5 cm / 5"

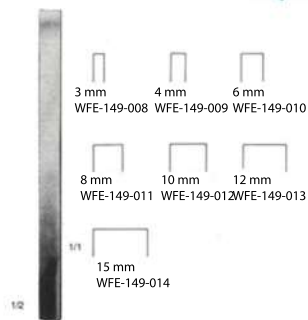

Mini-Lambotte
WFE-149-008-WFE-149-014
17.0 cm / 6 $\frac{3}{4}$ "

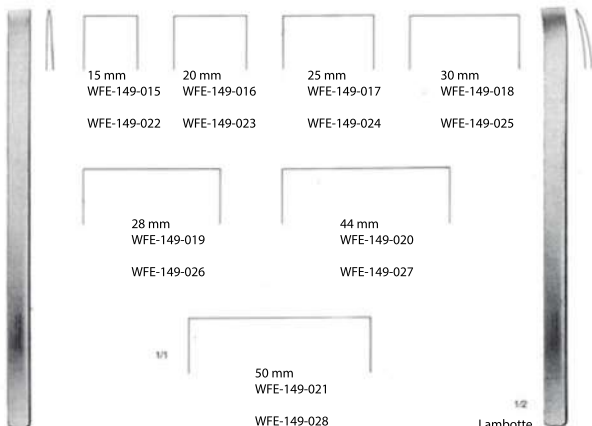

Lambotte
WFE-149-015-WFE-149-021
24.0 cm / 9 $\frac{1}{2}$ "

Lambotte
WFE-149-022-WFE-149-028
23.0 cm / 9"



Dressing Plaster Sheras, Bandage Scissors



6mm
WI-150-001



5mm
WI-150-001



9mm
WFE-150-002

3mm
WFE-150-001



9mm
WFE-150-002



13mm
WFE-150-003



13mm
WFE-150-003



16mm
WFE-150-004



16mm
WFE-150-004



19mm
WFE-150-005.



19mm
WFE-150-005.



25mm
WFE-150-006



25mm
WFE-150-006



32mm
WFE-150-007



32mm
WFE-150-007



9mm
WFE-150-015



9mm
WFE-150-019



14mm
WFE-150-016



14mm
WFE-150-020



19mm
WFE-150-017



19mm
WFE-150-021



25mm
WFE-150-018



25mm
WFE-150-022

Smith-Petersen
WFE-150-001-WFE-150-022
20.0 cm / 8"



Bone Surgery Bone Chisel and Gouges

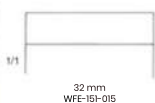
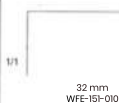

Hoke
WFE-151-001-WFE-151-005
17.0 cm / 6 3/4"

Hibbs
WFE-151-006-WFE-151-010
24.0cm / 9 1/2"

Hibbs
WFE-151-011-WFE-151-015
24.0cm / 9 1/2"



Bone Surgery Bone Chisel and Gouges



Hibbs
WFE-152-016-WFE-152-020
24.0 cm / 9 1/2"

Hibbs
WFE-152-021-WFE-152-025
24.0 cm / 9 1/2"

Hibbs
WFE-152-026-WFE-152-030
24.0 cm / 9 1/2"

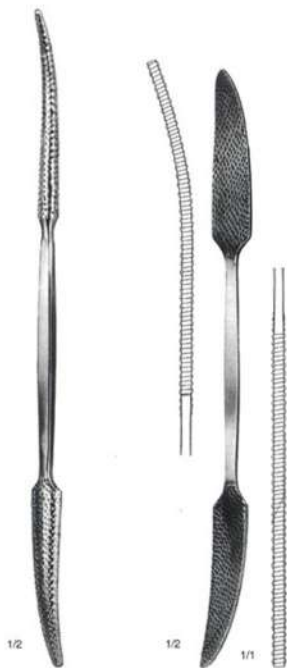

Putti
WFE-153-001
30.0 cm / 12"

Putti
WFE-153-002
27.0 cm / 10 5/8"



WFE-153-003-WFE-153-009
15.5 cm / 6"

1/1
2 mm Ø
WFE-153-003

3 mm Ø
WFE-153-004

4 mm Ø
WFE-153-005

5 mm Ø
WFE-153-006

6 mm Ø
WFE-153-007

8 mm Ø
WFE-153-008

1/1
10 mm Ø
WFE-153-009



Bone Surgery Mallets

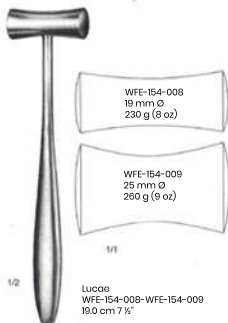
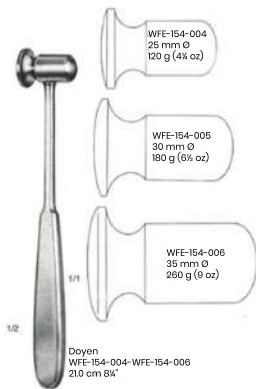
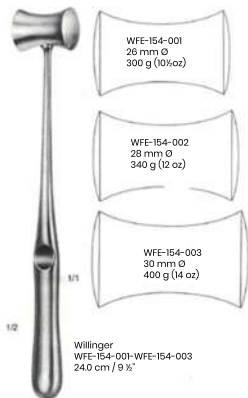

Bone Surgery Mallets



30 mm Ø
510 g (18 oz)



1/2

WFE-155-011
26.5 cm / 10½"

With interchangeable
Ferrozell faces

26 mm Ø
320 g (11 ¼ oz)



1/2

Mead
WFE-155-012
17.0 cm / 6 ¾"
Solid

Ferrozell faces only, pair

22 mm Ø
200 g (7 oz)



1/2

Partsch
WFE-155-013
18.0 cm / 7"

45 mm Ø
290 g (10 oz)



1/2

WFE-155-014
23.0 cm / 9"
hardwood, lead fitted



Bone Surgery Mallets



80 x 60 mm Ø
400 g



1/2

Steinbach
WFE-156-015
24.0 cm / 9 1/2"

Ferrozell. solid

42 mm Ø
250 g
400 g



1/2

WFE-156-016
26.0 cm / 10 1/4"

plastic, lead filled

W-156-017
26.0 cm / 10 1/4"

Ferrozell. Without Lead

42 mm Ø
250 g



1/2

WFE-156-018
26.0 cm / 10 1/4"

Ferrozell. Lead filled



1/2

WFE-156-019
26.5 cm / 10 1/2"

repercussion free



Bone Surgery Mallets



WFE-157-023
Spare Faces, pair

42 mm Ø
530 g (19 oz)

30 mm Ø



1/2

WFE-157-020
26.5 cm / 10 1/2"

steel, solid
with plastic handle

30 mm Ø
480 g



1/2

WFE-157-021
24.0 cm / 9 1/2"

steel, solid
with plastic handle

37 mm Ø
370 g



1/2

WFE-157-022
22.5 cm / 9"

steel, solid
with Ferrozell faces

30 mm
125 g (4 oz)



1/2

WFE-157-024
22.5 cm / 9"

Ferozell solid





450 g (1 lb)

900 g (2 lbs)



WFE-158-025
24.0 cm / 9 1/2"

steel, solid
with plastic handle



WFE-158-026
26.5cm / 10 1/2"

steel, solid



WFE-158-027
26.5cm / 10 1/2"

steel, solid



Bone Surgery Bone Curettes



Valkmann
WFE-159-001-WFE-159-010
17.0 cm / 6 3/4"

Handle from artificial wood



Valkmann
WFE-159-001-WFE-159-015
27.0 cm / 10 3/4"

Handle from artificial wood



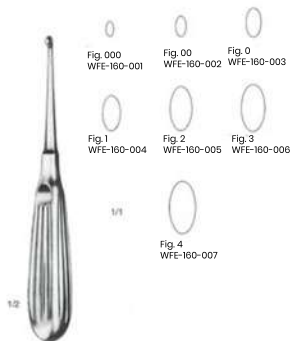

Schede
WFE-160-001-WFE-160-007

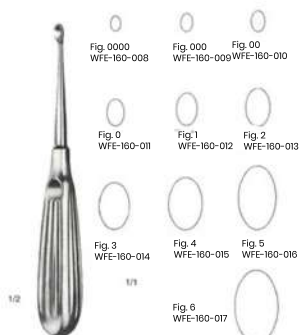

Volkmann
WFE-160-008-WFE-160-017

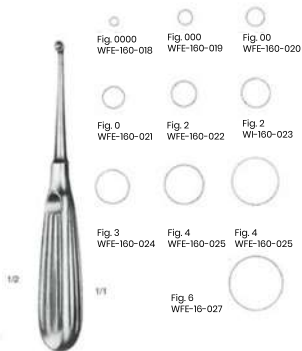

Bruns
WFE-160-018-WFE-160-027

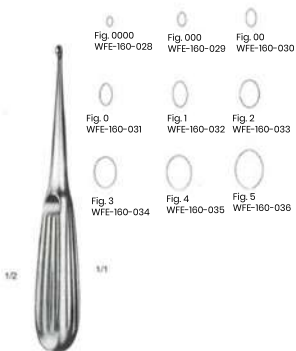

Spratt
WFE-160-028-WFE-160-036





○
WFE-161-009

○
WFE-161-010

○
WFE-161-011

○
WFE-161-012

○
WFE-161-013

○
WFE-161-014

○
WFE-161-015

○
WFE-161-016

○
WFE-161-017



WFE-161-018



WFE-161-019



WFE-161-020

○
Fig. 00
WFE-161-001

○
Fig. 00
WFE-161-005

○
Fig. 0
WFE-161-002

○
Fig. 0
WFE-161-006

○
Fig. 1
WFE-161-003

○
Fig. 1
WFE-161-007

○
Fig. 2
WFE-161-004

○
Fig. 2
WFE-161-008

1/2

Willinger
WFE-161-001-WFE-161-008
17.5 cm / 7"

1/2

Bruns
WFE-161-009-WFE-161-017
23.5 cm / 9"

1/2

WFE-161-018-WFE-161-020
23.5 cm / 10"



Bone Surgery Bone Curettes

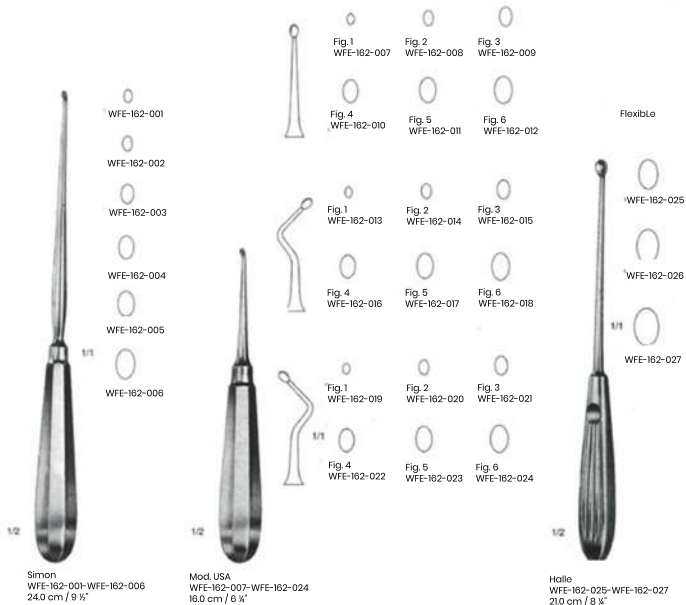

Simon
WFE-162-001-WFE-162-006
24.0 cm / 9 1/2"

Mod. USA
WFE-162-007-WFE-162-024
16.0 cm / 6 1/4"

Halle
WFE-162-025-WFE-162-027
21.0 cm / 8 1/4"



Bone Surgery Bone Curettes



1/1

WFE-163-001
13.0 cm / 5"



WFE-163-002
14.0 cm / 5½"



WFE-163-003
17.0 cm / 6¾"



1/1

WFE-163-004
13.0 cm / 5"



WFE-163-005
16.0 cm / 6¾"



WFE-163-006
20.0 cm / 8"

1/2

Volkman
WFE-163-001-WFE-163-003

Volkman
WFE-163-004-WFE-163-006



1/1

WFE-163-007
21.0 cm / 8¾"
oval/round

1/1



1/2

Williger
WFE-163-008-WFE-163-010
13.5 cm / 5¼"



00

1/1



0

WFE-163-008



0

1/1



1

WFE-163-009



1

1/1



2

WFE-163-010



00

1/1



0

WFE-163-011



0

1/1



1

WFE-163-012



1

1/1



2

WFE-163-013

1/2



Martini
WFE-163-011-WFE-163-013
13.5 cm / 5¼"



Bone Surgery Bone Curettes



Spinal Fusion Curettes 23.0 cm / 9", reverse angle

- WFE-164-01 - Size 5-0
- WFE-164-002 - Size 4-0
- WFE-164-003 - Size 3-0
- WFE-164-004 - Size 2-0
- WFE-164-005 - Size 0
- WFE-164-006 - Size 1
- WFE-164-007 - Size 2**
- WFE-164-008 - Size 3
- WFE-164-009 - Size 4
- WFE-164-010 - Size 5
- WFE-164-011 - Size 6

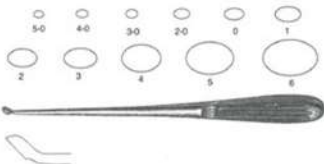

Bruns Oval Cup Curettes 23.0 cm / 9", straight solid hexagonal handle

- WFE-164-012 - Size 3-0
- WFE-164-013 - Size 2-0
- WFE-164-014 - Size 0
- WFE-164-015 - Size 1
- WFE-164-016 - Size 2
- WFE-164-017 - Size 3
- WFE-164-018 - Size 4**
- WFE-164-019 - Size 5
- WFE-164-020 - Size 6

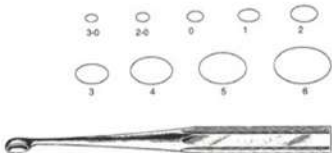

Semmes (howard) Spinal Curettes 23.0 cm / 9" 4 x 7 mm cup

- WFE-164-021 - Straight
- WFE-164-022 - Slight angle
- WFE-164-023 - Acute Angle



Cobb-Type Oval Cup Curettes 27.9 cm / 11", hollow knurled handle

- | Staright | Angled Tip | |
|--------------------|--------------------|---------------|
| WFE-164-024 | WFE-164-033 | Size 3-0 |
| WFE-164-025 | WFE-164-034 | Size 2-0 |
| WFE-164-026 | WFE-164-035 | Size 0 |
| WFE-164-027 | WFE-164-036 | Size 1 |
| WFE-164-028 | WFE-164-037 | Size 2 |
| WFE-164-029 | WFE-164-038 | Size 3 |
| WFE-164-030 | WFE-164-039 | Size 4 |
| WFE-164-031 | WFE-164-040 | Size 5 |
| WFE-164-032 | WFE-164-041 | Size 6 |

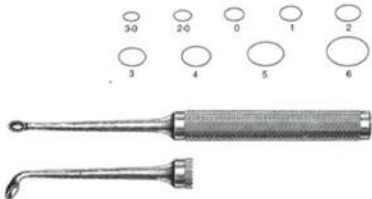

Bone Surgery

Bone Curettes and Hooks



Bone Hooks
23.0 cm / 9"

WFE-165-001 - 9.5 mm / $\frac{3}{8}$ " hook
WFE-165-002 - 19 mm / $\frac{3}{4}$ " hook
WFE-165-003 - 25 mm / 1" hook

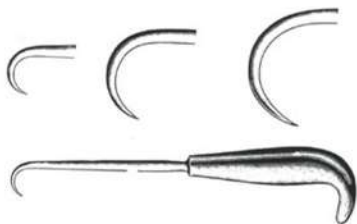

Volkmann bone Curettes
double ended

WFE-165-004 - 13.0 cm / 5" one round and one oval cup
10.5 mm and 6.3 mm x 6.8 mm
WFE-165-005 - 16.5 cm 6 $\frac{1}{2}$ " two oval cups
7.5 mm x 14 mm and 9mm x 22mm
WFE-165-006 - 8.5 cm 8 $\frac{1}{2}$ " one round and one oval cup
14 mm and 7mm x 9mm
WFE-165-007 - 20.0 cm / 8" one round and one oval cup
17.5mm x and 9 mm x 11 mm



Scoville Disc Curettes
25.0 cm / 10" . 4 x 10mm cup

WFE-165-008 - Straight
WFE-165-009 - Reverse angled
WFE-165-010 - Angled



Dressing Plaster Sheras, Bandage Scissors



WI-146-001
2mm



WI-146-002
3mm



WI-146-002
4mm



WI-146-004
2mm



WI-146-005
3mm



WI-146-006
4mm

Buckley
WI-146-001-WI-140-006
16.0 cm / 6 1/4"



WI-146-007
8mm



WI-146-008
10mm



WI-146-009
12mm



WI-146-010
14mm



WI-146-011
16mm

WI-146-007-WI-140-011
13.5 cm / 5"



WI-146-012
8mm



WI-146-013
10mm



WI-146-014
12mm



WI-146-015
14mm



WI-146-016
16mm

WI-14-012-WI-14-016
13.5 cm / 5 1/4"



WI-146-017
8mm



WI-146-018
10mm



WI-146-019
12mm



WI-146-020
14mm



WI-146-021
16mm

WI-14-017-WI-14-021
13.5 cm / 5 1/4"



Dressing Plaster Sheras, Bandage Scissors



WFE-147-001
11.0 cm / 1½"



WFE-147-002
11.0 cm / 1½"



WFE-147-003
10.0 cm / 4"



WFE-147-004
10.0 cm / 4"

Buck-Gramcko
WFE-147-001 WFE-147-004



4 mm
WFE-147-025



4 mm
WFE-147-031



2mm WFE-147-005 2mm WFE-147-010
13.5 cm / 5¼" 17.0 cm / 6¾"



2mm WFE-147-015 2mm WFE-147-020
13.5 cm / 5¼" 17.0 cm / 6¾"



6 mm
WFE-147-026



6 mm
WFE-147-032



3mm WFE-147-006 3mm WFE-147-011
13.5 cm / 5¼" 17.0 cm / 6¾"



3mm WFE-147-016 3mm WFE-147-021
13.5 cm / 5¼" 17.0 cm / 6¾"



8 mm
WFE-147-027



8 mm
WFE-147-033



4mm WFE-147-007 4mm WFE-147-012
13.5 cm / 5¼" 17.0 cm / 6¾"



4mm WFE-147-017 4mm WFE-147-022
13.5 cm / 5¼" 17.0 cm / 6¾"



10 mm
WFE-147-028



10 mm
WFE-147-034



5mm WFE-147-008 5mm WFE-147-012
13.5 cm / 5¼" 17.0 cm / 6¾"



5mm WFE-147-018 5mm WFE-147-023
13.5 cm / 5¼" 17.0 cm / 6¾"



12 mm
WFE-147-028



12 mm
WFE-147-035



6 mm WFE-147-009 6 mm WFE-147-012
13.5 cm / 5¼" 17.0 cm / 6¾"



6 mm WFE-147-019 6 mm WFE-147-024
13.5 cm / 5¼" 17.0 cm / 6¾"



14 mm
WI-147-030



14 mm
WFE-147-036

Partsch
WFE-147-005-WFE-147-024

Alexander
WFE-147-025-WFE-147-036
18.0 cm / 7"



WORTH FIELD
ENTERPRISES

Dressing Plaster Sheras, Bandage Scissors



10 mm
WFE-148-001



10 mm
WFE-148-005



10 mm
WFE-148-009



15 mm
WFE-148-003



15 mm
WFE-148-006



15 mm
WFE-148-010



20 mm
WFE-148-004



20 mm
WFE-148-007



20 mm
WFE-148-011

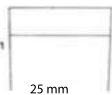

25 mm
WFE-148-004

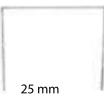

25 mm
WFE-148-008



25 mm
WFE-148-012



Stille
WFE-148-001-WFE-148-012
20.0 cm / 8"



Dressing Plaster Sheras, Bandage Scissors

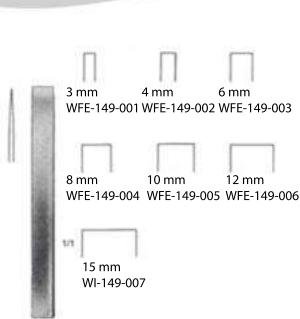

Mini-Lambotte
WFE-149-001-WFE-149-007
12.5 cm / 5"

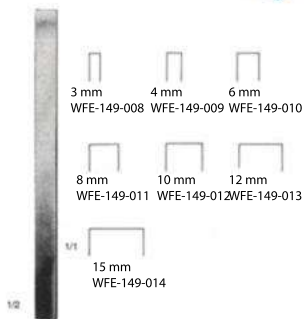

Mini-Lambotte
WFE-149-008-WFE-149-014
17.0 cm / 6 $\frac{3}{4}$ "

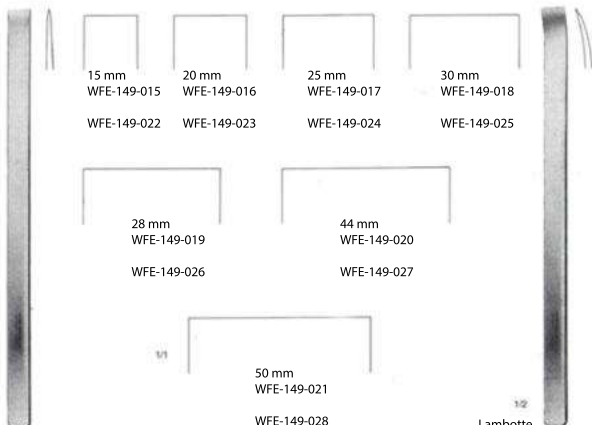

Lambotte
WFE-149-015-WFE-149-021
24.0 cm / 9 $\frac{1}{2}$ "

Lambotte
WFE-149-022-WFE-149-028
23.0 cm / 9"



Dressing Plaster Sheras, Bandage Scissors



6mm
WI-150-001



5mm
WI-150-001



9mm
WFE-150-002

3mm
WFE-150-001



9mm
WFE-150-002



13mm
WFE-150-003



13mm
WFE-150-003



16mm
WFE-150-004



16mm
WFE-150-004



19mm
WFE-150-005.



19mm
WFE-150-005.



25mm
WFE-150-006



25mm
WFE-150-006



32mm
WFE-150-007



32mm
WFE-150-007



9mm
WFE-150-015



9mm
WFE-150-019



14mm
WFE-150-016



14mm
WFE-150-020



19mm
WFE-150-017



19mm
WFE-150-021



25mm
WFE-150-018



25mm
WFE-150-022

Smith-Petersen
WFE-150-001-WFE-150-022
20.0 cm / 8"



Bone Surgery Bone Chisel and Gouges



Hoke
WFE-151-001-WFE-151-005
17.0 cm / 6 3/4"

Hibbs
WFE-151-006-WFE-151-010
24.0cm / 9 1/2"

Hibbs
WFE-151-011-WFE-151-015
24.0cm / 9 1/2"



WORTH FIELD
ENTERPRISES

Bone Surgery Bone Chisel and Gouges



Hibbs
WFE-152-016-WFE-152-020
24.0 cm / 9 1/2"

Hibbs
WFE-152-021-WFE-152-025
24.0 cm / 9 1/2"

Hibbs
WFE-152-026-WFE-152-030
24.0 cm / 9 1/2"

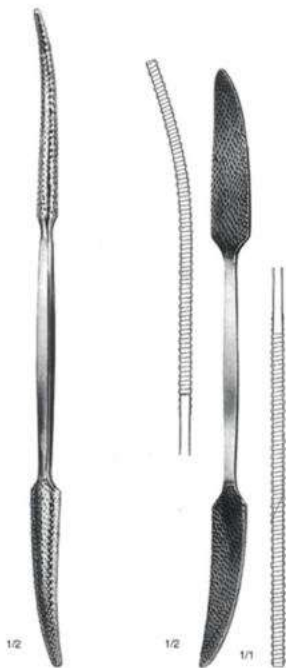

Putti
WFE-153-001
30.0 cm /12"

Putti
WFE-153-002
27.0 cm./10 1/2"

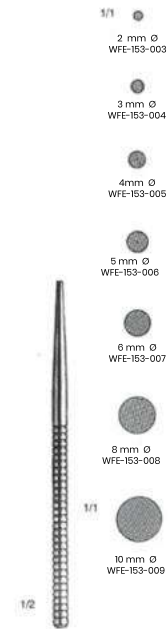

WFE-153-003-WFE-153-009
15.5 cm /6"



Bone Surgery Mallets

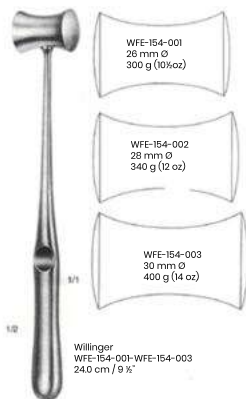

Willinger
WFE-154-001-WFE-154-003
24.0 cm / 9 ½"

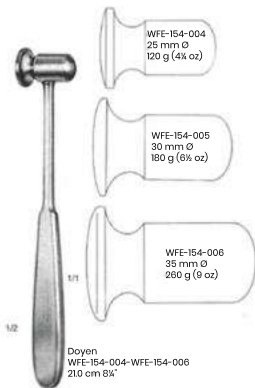

Doyen
WFE-154-004-WFE-154-006
21.0 cm 8 ¼"



Collin
WFE-154-007
20.0 cm / 8"



Lucas
WFE-154-008-WFE-154-009
19.0 cm 7 ½"

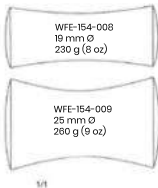

WFE-154-010
18.5 cm / 6 ¾"



Bone Surgery Mallets



30 mm Ø
510 g (18 oz)



1/2

WFE-155-011
26.5 cm / 10 1/2"

With interchangeable
Ferrozell faces

26 mm Ø
320 g (11 1/4 oz)



1/2

Mead
WFE-155-012
17.0 cm / 6 3/4"
Solid

Ferrozell faces only, pair

22 mm Ø
200 g (7 oz)



1/2

Partsch
WFE-155-013
18.0 cm / 7"

45 mm Ø
290 g (10 oz)



1/2

WFE-155-014
23.0 cm / 9"
hardwood, lead fitted



Bone Surgery Mallets



80 x 60 mm Ø
400 g



Steinbach
WFE-156-015
24.0 cm / 9 1/2"

Ferrozell. solid

42 mm Ø
250 g
400 g



WFE-156-016
26.0 cm / 10 1/4"

plastic, lead filled

W1-156-017
26.0 cm / 10 1/4"

Ferrozell. Without Lead

42 mm Ø
250 g



WFE-156-018
26.0 cm / 10 1/4"

Ferrozell. Lead filled



WFE-156-019
26.5 cm / 10 1/2"

repercussion free



Bone Surgery Mallets



WFE-157-023
Spare Faces, pair

42 mm Ø
530 g (19 oz)

30 mm Ø



1/2

WFE-157-020
26.5 cm / 10 1/2"

steel, solid
with plastic handle

30 mm Ø
480 g



1/2

WFE-157-021
24.0 cm / 9 1/2"

steel, solid
with plastic handle

37 mm Ø
370 g



1/2

WFE-157-022
22.5 cm / 9"

steel, solid
with Ferrozell faces

30 mm
125 g (4 oz)



1/2

WFE-157-024
22.5 cm / 9"

Ferrozell solid





450 g (1 lb)

900 g (2 lbs)



WFE-158-025
24.0 cm / 9 1/2"

steel, solid
with plastic handle



WFE-158-026
26.5cm / 10 1/2"

steel, solid



WFE-158-027
26.5cm / 10 1/2"

steel, solid



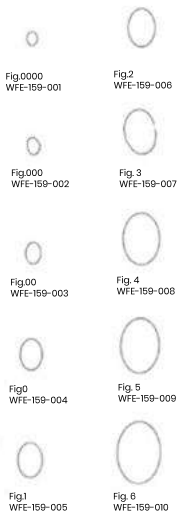

Volkman
WFE-159-001-WFE-159-010
17.0 cm / 6 3/4"

Handle from artificial wood

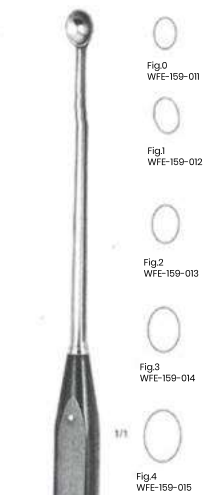

Volkman
WFE-159-001-WFE-159-015
27.0 cm / 10 3/4"

Handle from artificial wood



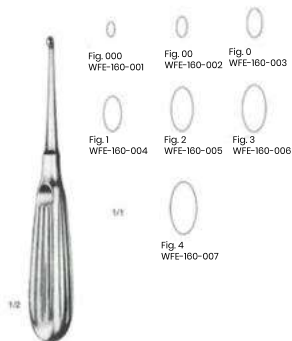

Schede
WFE-160-001-WFE-160-007

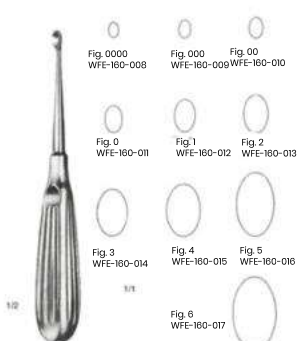

Volkmann
WFE-160-008-WFE-160-017

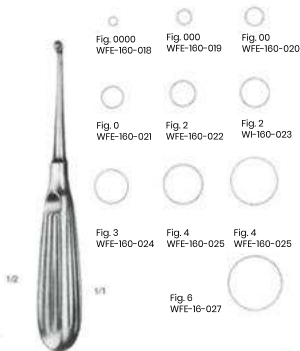

Bruns
WFE-160-018-WFE-160-027

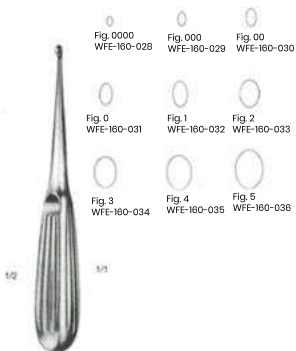

Spratt
WFE-160-028-WFE-160-036



Bone Surgery Bone Curettes

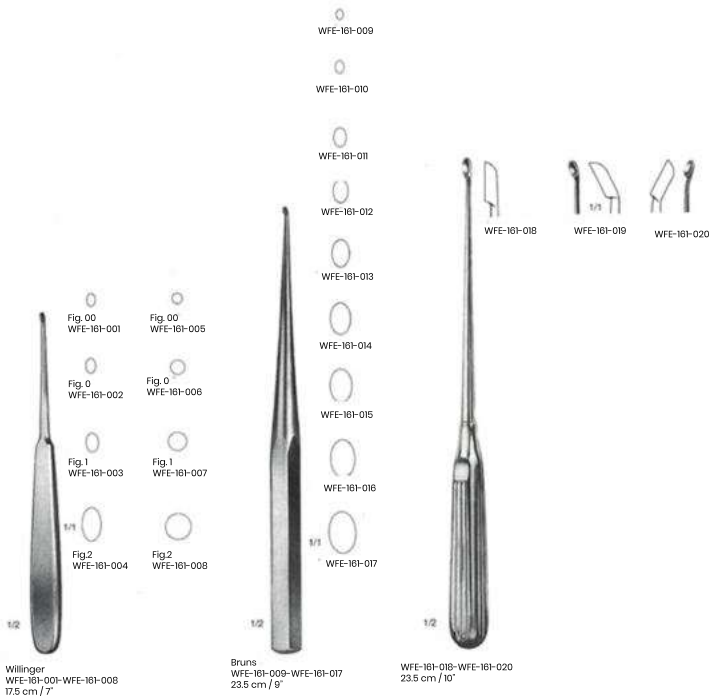

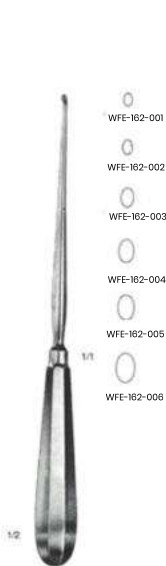

Simon
WFE-162-001-WFE-162-006
24.0 cm / 9 1/2"

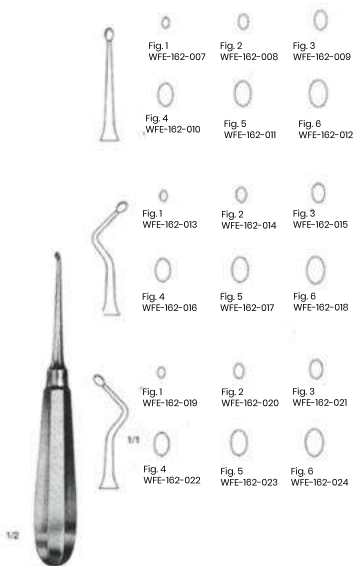

Mod. USA
WFE-162-007-WFE-162-024
16.0 cm / 6 1/4"

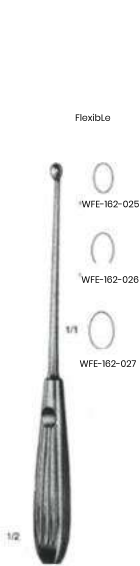

Halle
WFE-162-025-WFE-162-027
21.0 cm / 8 1/4"





1/1

WFE-163-001
13.0 cm / 5"



WFE-163-002
14.0 cm / 5½"



WFE-163-003
17.0 cm / 6¾"



1/1

WFE-163-004
13.0 cm / 5"



WFE-163-005
16.0 cm / 6¼"



WFE-163-006
20.0 cm / 8"

Volkman
WFE-163-001-WFE-163-003

Volkman
WFE-163-004-WFE-163-006



1/1

WFE-163-007
21.0 cm / 8¼"
oval/round

1/2



Williger
WFE-163-008-WFE-163-010
13.5 cm / 5¼"

1/2



1/1

WFE-163-008



1

WFE-163-009



2

WFE-163-010



1/1

WFE-163-011



1

WFE-163-012



2

WFE-163-013

1/2

Martini
WFE-163-011-WFE-163-013
13.5 cm / 5¼"



Bone Surgery Bone Currettes



Spinal Fusion Currettes 23.0 cm / 9", reverse angle

- WFE-164-01 - Size 5-0
- WFE-164-002 - Size 4-0
- WFE-164-003 - Size 3-0
- WFE-164-004 - Size 2-0
- WFE-164-005 - Size 0
- WFE-164-006 - Size 1
- WFE-164-007 - Size 2**
- WFE-164-008 - Size 3
- WFE-164-009 - Size 4
- WFE-164-010 - Size 5
- WFE-164-011 - Size 6

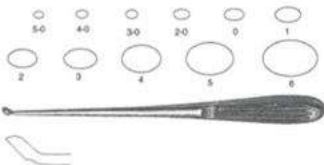

Bruns Oval Cup Currettes 23.0 cm / 9", straight solid hexagonal handle

- WFE-164-012 - Size 3-0
- WFE-164-013 - Size 2-0
- WFE-164-014 - Size 0
- WFE-164-015 - Size 1
- WFE-164-016 - Size 2
- WFE-164-017 - Size 3
- WFE-164-018 - Size 4**
- WFE-164-019 - Size 5
- WFE-164-020 - Size 6

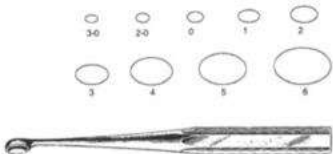

Semmes (howard) Spinal Currettes 23.0 cm / 9" 4 x 7 mm cup

- WFE-164-021 - Straight
- WFE-164-022 - Slight angle
- WFE-164-023 - Acute Angle



Cobb-Type Oval Cup Currettes 27.9 cm / 11", hollow knurled handle

- | Staright | Angled Tip | |
|--------------------|--------------------|---------------|
| WFE-164-024 | WFE-164-033 | Size 3-0 |
| WFE-164-025 | WFE-164-034 | Size 2-0 |
| WFE-164-026 | WFE-164-035 | Size 0 |
| WFE-164-027 | WFE-164-036 | Size 1 |
| WFE-164-028 | WFE-164-037 | Size 2 |
| WFE-164-029 | WFE-164-038 | Size 3 |
| WFE-164-030 | WFE-164-039 | Size 4 |
| WFE-164-031 | WFE-164-040 | Size 5 |
| WFE-164-032 | WFE-164-041 | Size 6 |

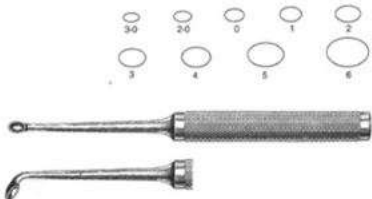

Bone Surgery

Bone Curettes and Hooks



Bone Hooks

23.0 cm / 9"

- WFE-165-001 - 9.5 mm / $\frac{3}{8}$ " hook
- WFE-165-002 - 19 mm / $\frac{3}{4}$ " hook
- WFE-165-003 - 25 mm / 1" hook

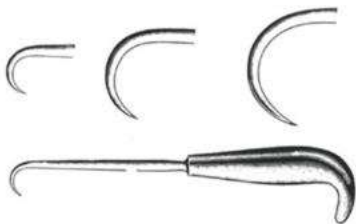

Volkman bone Curettes

double ended

- WFE-165-004 - 13.0 cm / 5" one round and one oval cup
10.5 mm and 6.3 mm x 6.8 mm
- WFE-165-005 - 16.5 cm 6 $\frac{1}{2}$ " two oval cups
7.5 mm x 14 mm and 9mm x 22mm
- WFE-165-006 - 8.5 cm 8 $\frac{1}{2}$ " one round and one oval cup
14 mm and 7mm x 9mm
- WFE-165-007 - 20.0 cm / 8" one round and one oval cup
17.5mm x and 9 mm x 11 mm



Scoville Disc Curettes

25.0 cm / 10" . 4 x 10mm cup

- WFE-165-008 - Straight
- WFE-165-009 - Reverse angled
- WFE-165-010 - Angled



Bone Surgery Bone Curettes



Cone Ring curettes 23.0 cm / 9"

- WFE-166-011 - Straight, Size 1, 8mm diameter
- WFE-166-012 - Straight, Size 2, 6mm diameter
- WFE-166-013 - Straight, Size 3, 3mm diameter
- WFE-166-014 - Angular, Size 1, 8mm diameter
- WFE-166-015 - Angular, Size 2, 6mm diameter
- WFE-166-016 - Angular, Size 3, 3mm diameter

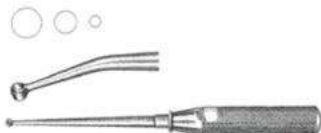

Cone Ring curettes 23.0 cm / 9", 8mm cup

- WFE-166-017- 5° Angle
- WFE-166-018- 30° Angle

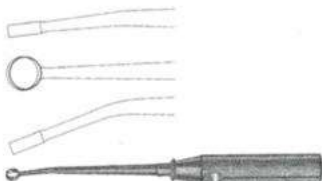

Epstein Spinal curettes 20.0 cm / 8", reverse angle

- WFE-166-019- Size 3-0
- WFE-166-020- Size 2-0
- WFE-166-021- Size 0



Bone Surgery Periosteal Raspatories

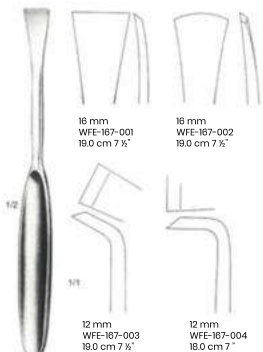

Langenbeck
WFE-167-001-WFE-167-004

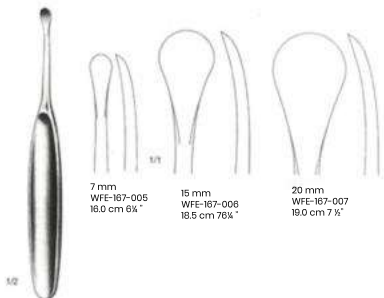

Hoen
WFE-167-005-WFE-167-007

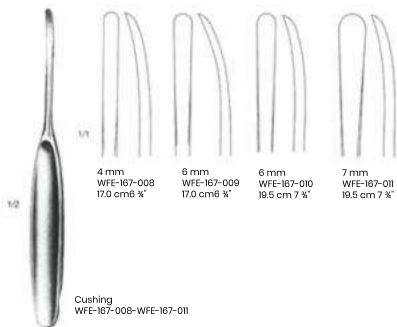

Cushing
WFE-167-008-WFE-167-011

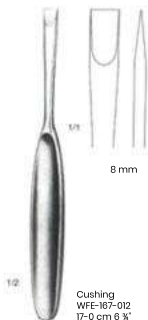

Cushing
WFE-167-012
17.0 cm 6 3/4"



Bone Surgery Periosteal Raspatories

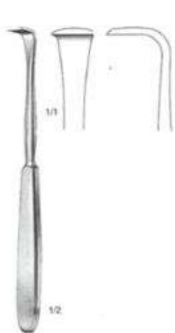

Langenbeck
WFE-168-013
18.0 cm / 7"

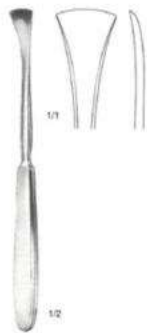

Langenbeck
WFE-168-014
19.0 cm / 7 1/2"

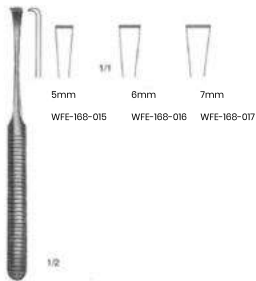

WFE-168-015-WFE-168-017
16.0 cm / 6 1/4"

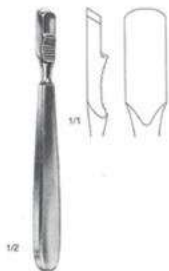

Farabeuf
WFE-168-018
15.0 cm / 6"



Farabeuf
WFE-168-019
15.0 cm / 6"

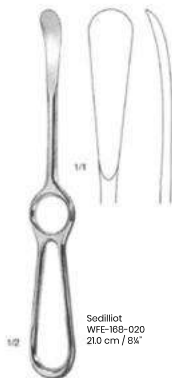

Sedillot
WFE-168-020
21.0 cm / 8 1/4"



Bone Surgery Periosteal Raspatories

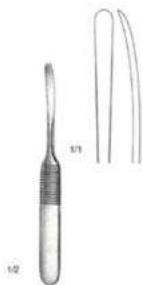

Williger
WFE-169-021
13.0 cm / 5"



Williger
WFE-169-022
16.0 cm / 6 1/4"

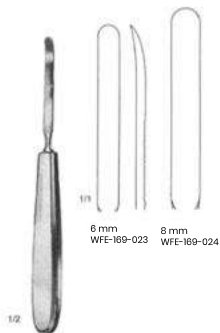

8 mm WFE-169-023
8 mm WFE-169-024

WFE-169-023-WFE-169-024
17.0 cm / 6 3/4"



Doyen
WFE-169-025-WFE-169-028
17.0 cm / 6 3/4"

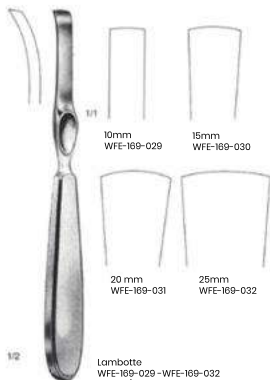

10mm WFE-169-029
15mm WFE-169-030

20 mm WFE-169-031
25mm WFE-169-032

Lambotte
WFE-169-029 - WFE-169-032
20 cm / 8 1/4"





WFE-170-033
17.5 cm / 7"

WFE-170-034
21.0 cm / 8 1/4"

WFE-170-035
17.5 cm / 7"

WFE-170-036
21.0 cm / 8 1/4"

WFE-170-031
20.5 cm / 8"

Semb
WFE-170-033-WFE-170-037

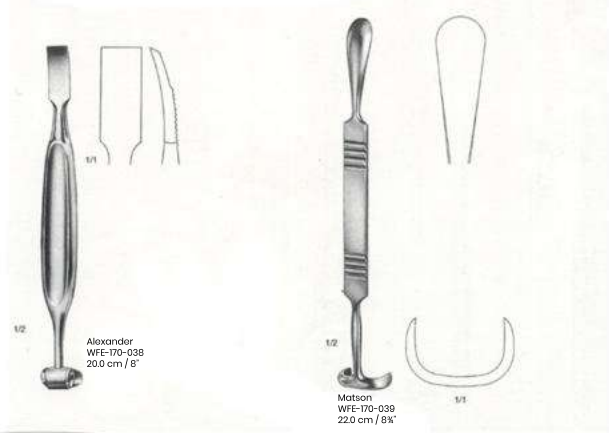

Alexander
WFE-170-038
20.0 cm / 8"

Matson
WFE-170-039
22.0 cm / 8 1/2"



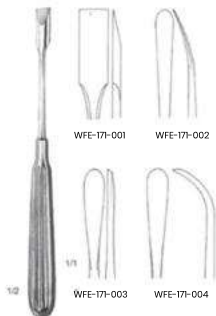

Adson
WFE-171-001-WFE-171-004
17.0 cm / 6 3/4"

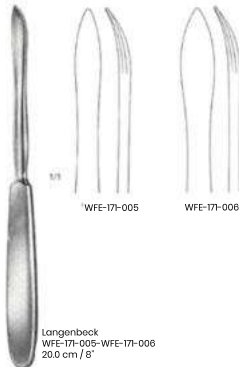

Langenbeck
WFE-171-005-WFE-171-006
20.0 cm / 8"



Williger
WFE-171-007
17.0 cm / 6 3/4"

Williger
WFE-171-008
16.0 cm / 6 1/4"

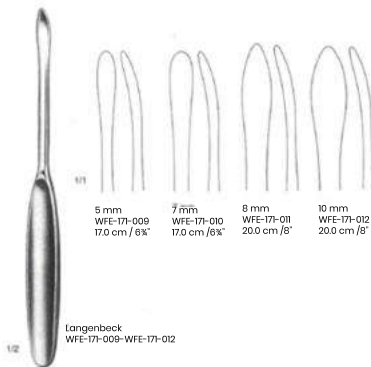

5 mm
WFE-171-009
17.0 cm / 6 3/4"

7 mm
WFE-171-010
17.0 cm / 6 3/4"

8 mm
WFE-171-011
20.0 cm / 8"

10 mm
WFE-171-012
20.0 cm / 8"

Langenbeck
WFE-171-009-WFE-171-012





WFE-172-013
17.5 cm / 6 3/4"

extremely lightweight



Micro Elevator
WFE-172-014
16.0 cm / 6 1/4"



6 mm
WFE-172-015



19 mm
WFE-172-017



12 mm
WFE-172-016



25 mm
WFE-172-018

Key
WFE-172-015-WFE-172-018
19.0 cm / 7 1/2"



WFE-172-019
16.0 cm / 6 1/4"



Alderdyce
WFE-172-020
21.0 cm / 8 1/4"



Mcdonald
WFE-172-021
19.0 cm / 7 1/2"



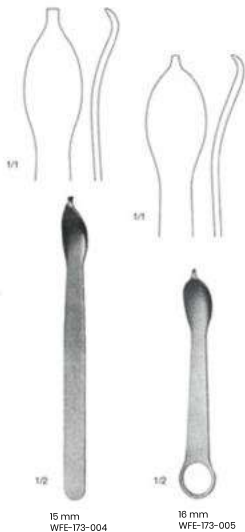
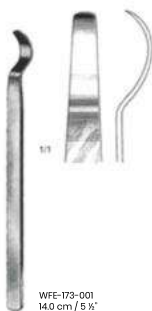

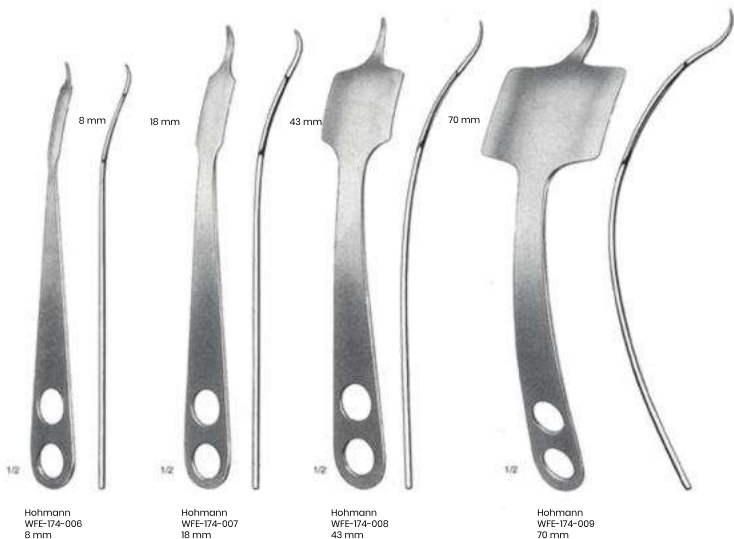

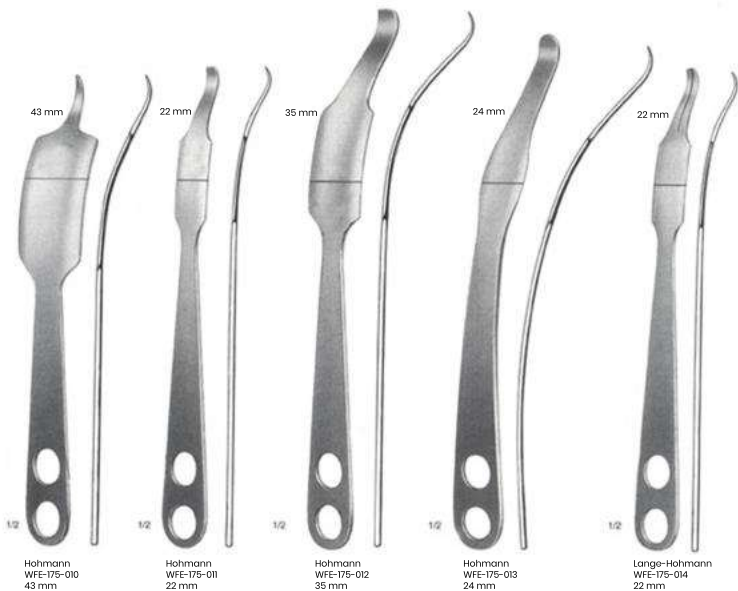

Bone Surgery Bone Levers and Spinal Retractors



Bennett
WFE-175-015
24.0 cm / 9 1/2"



Blount
WFE-175-016
26.0 cm / 10 1/4"



Blount
WFE-175-017
26.0 cm / 10 1/4"

Spinal Retractor

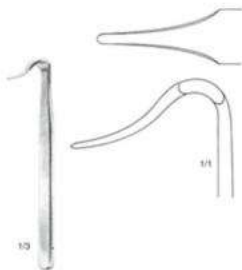

Blount kneeol Retractors
WFE-175-018
17.5 cm / 7"

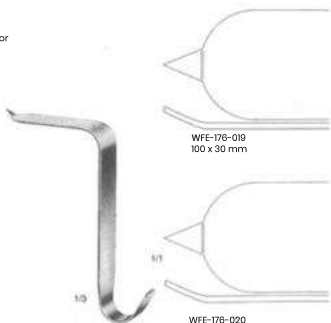

WFE-176-019
100 x 30 mm

WFE-176-020
75 x 30 mm

Taylor Spinal Retractors
WFE-175-019-WFE-175-020
18.5 cm / 8 1/2"
100 x 30 mm 75 x 30 mm



Bone Surgery Menisectomy Knives

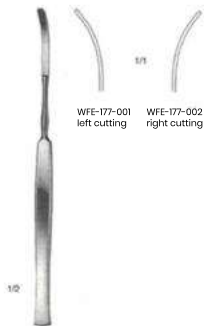

WFE-177-001 left cutting
WFE-177-002 right cutting

Mod. Schweden
WFE-177-001-WFE-177-002
17.0 cm / 6 3/4"

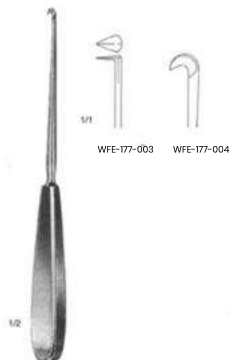

WFE-177-003
WFE-177-004

Bircher
WFE-177-003-WFE-177-004
19.0 cm / 7 1/2"

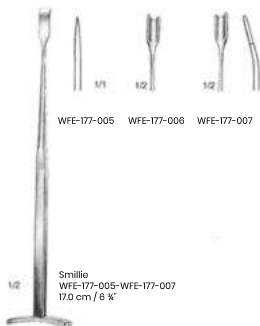

WFE-177-005
WFE-177-006
WFE-177-007

Smillie
WFE-177-005-WFE-177-007
17.0 cm / 6 3/4"

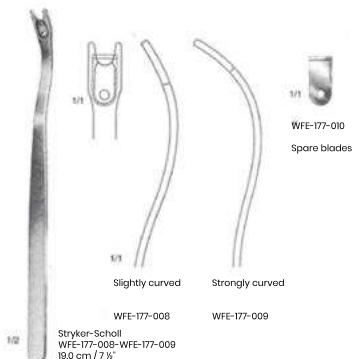

Slightly curved
Strongly curved

WFE-177-008
WFE-177-009

Stryker-Scholl
WFE-177-008-WFE-177-009
19.0 cm / 7 1/2"

WFE-177-010
Spare blades





WFE-178-001
13.5 cm / 5 1/4"



Dingmann
WFE-178-002
19.0cm / 7 1/2"



Special Model
WFE-178-003
19.0cm / 7 1/2"



WFE-178-004
12.0 cm / 4 3/4"



Lowin
WFE-178-005
17.5 cm / 7"

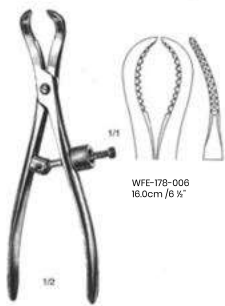

WFE-178-006
16.0cm / 6 1/4"

WFE-178-006-WFE-178-007

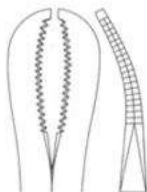

WFE-178-007
24.0cm / 9 1/2"



Bone Surgery Bone Holding Forceps



WFE-179-008
14.0 cm / 5 1/2"



WFE-179-009
13.5 cm / 5 1/4"



Langenbeck
WFE-179-010
21.0 cm / 8 1/4"

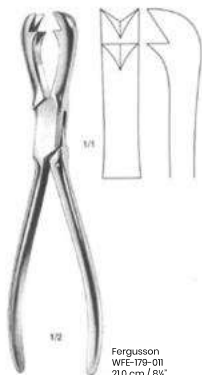

Fergusson
WFE-179-011
21.0 cm / 8 1/4"



Frosch
WFE-179-012
18.0 cm / 7"



WFE-179-013
20.0 cm / 8"



Bone Surgery Bone Holding Forceps

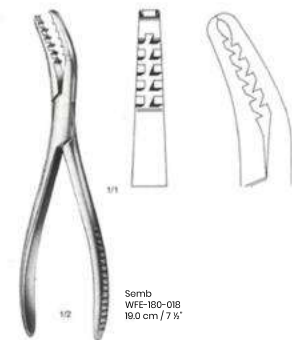
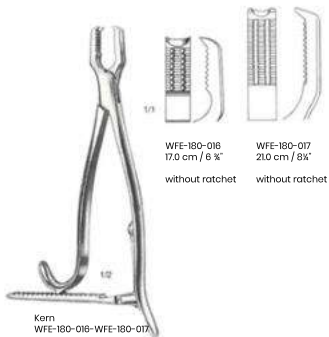
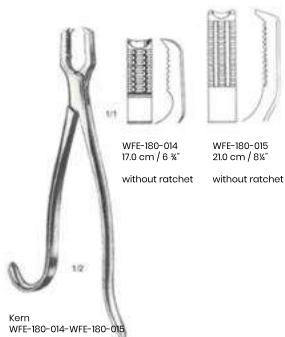

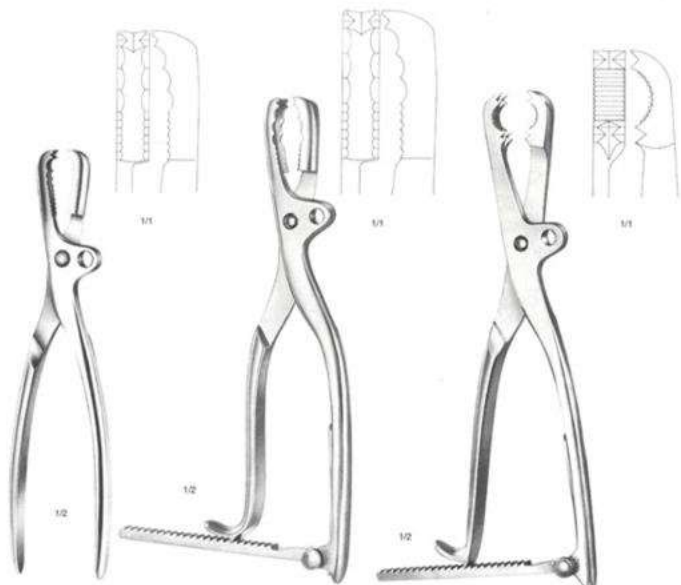

Farebeuf
WFE-181-001- 23.0 cm /9"
WFE-181-002- 26.0 cm /10 1/2"

Farebeuf-Lambotto
WFE-181-003
26.0 cm /10 1/2"

Tuffler
WFE-181-004
27.0 cm /10 1/2"



Bone Surgery Bone Holding Forceps



Lambotte
WFE-182-005 - 22.0 cm / 8 5/8"
WFE-182-006 - 27.0 cm / 10 1/2"
WFE-182-007 - 30.0 cm / 12"

Lambotte
WFE-182-008 - 22.0 cm / 8 5/8"
WFE--182-009 - 26.0 cm / 10 1/4"
WFE--182-010 - 33.0 cm / 13"

Lambotte
WFE-182-011- 19.0 cm / 7 1/2"
WFE-182-012 - 23.0 cm / 9"
WFE-182-013 - 26.0 cm / 10 1/4"



Bone Surgery Bone Holding Forceps

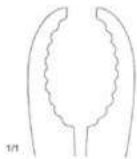
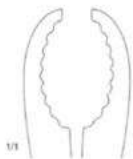

WFE-018-014
23.0 cm / 9"



WFE-018-015
25.0 cm / 10"



WFE-018-016
28.0 cm / 11"

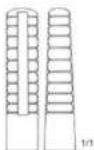

Ulrich
WFE-018-014- WFE-018-016



Ulrich
WFE-018-017
28.0 cm / 11"



Bone Surgery Bone Holding Forceps

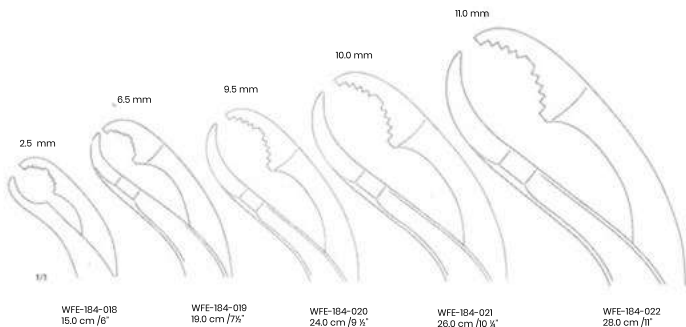

Self-centering forceps
with thread fixation



WFE-184-018-WFE-184-022





Lane
WFE-185-023-WFE-185-026

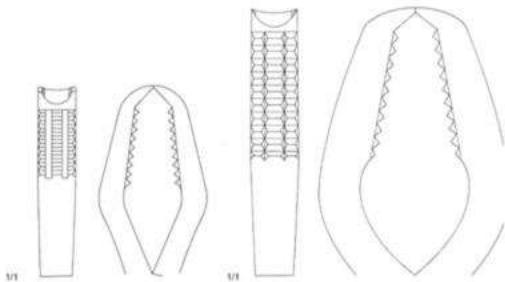

WFE-185-023
33.0 cm / 13"

Without ratchet

WFE-185-024
33.0 cm / 13"
With ratchet

WFE-185-025
45.0 cm / 17"

Without ratchet

WFE-185-026
45.0 cm / 17"
With ratchet



Bone Surgery Bone Holding Forceps, Retractors

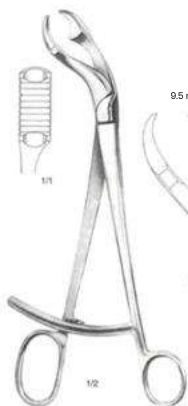

vebrugge
WFE-186-027-WFE-186-029

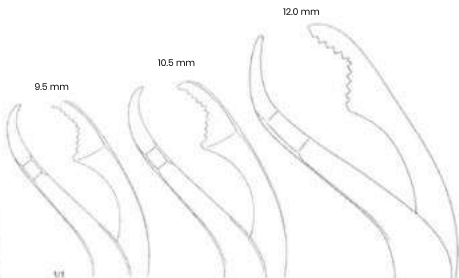

WFE-186-027
25.0 cm / 10"

WFE-186-028
26.0 cm / 10 1/4"

WFE-186-029
27.0 cm / 11"



Verbrugge
WFE-186-030
17.5 cm / 7"



Ampulating Retractor

Percy
WFE-186-031



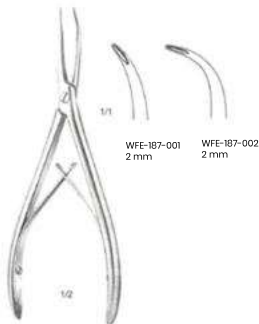

Stellbrink
WFE-187-001-WFE-187-002
17.0 cm / 6 3/4"



Mini-Friedman
WFE-187-003
13.0 cm / 5"



Friedman
WFE-187-004
14.0 cm / 5 1/2"



Cleveland
WFE-187-007
14.0 cm / 5 1/2"



Cleveland
WFE-187-008
17.0 cm / 6 3/4"



Universal
WFE-187-007
13.5 cm / 5 1/4"



Mead
WFE-187-008
16.5 cm / 6 1/2"





Mead
WFE-188-009
16.5 cm / 6 1/2"



Hartmann
WFE-188-010
18.5 cm / 7 1/4"



Jensen
WFE-188-011-WFE-188-013
18.0 cm / 7"

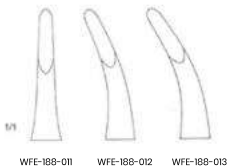

WFE-188-011

WFE-188-012

WFE-188-013

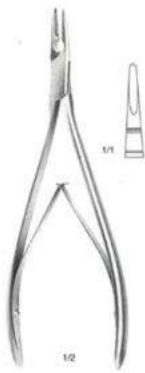

Lempert
WFE-188-014
19.0 cm / 7 1/2"



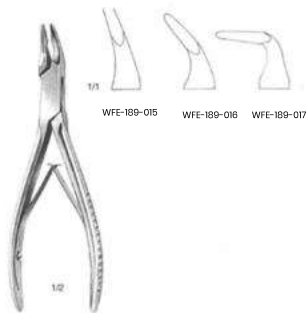

WFE-189-015

WFE-189-016

WFE-189-017

Blumenthal
WFE-189-015-WFE-189-017

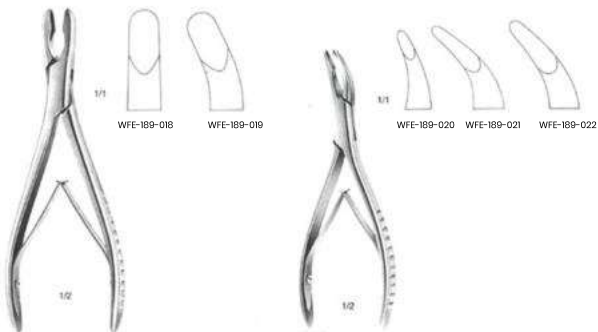

WFE-189-018

WFE-189-019

WFE-189-020

WFE-189-021

WFE-189-022

Lour
WFE-189-018-WFE-189-019
17.0 cm / 6 3/4"

Lour
WFE-189-020-WFE-189-022
15.0 cm / 6"



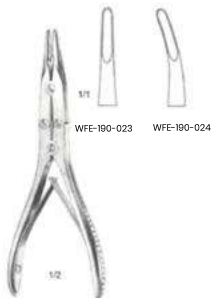

Bohler
WFE-190-023-WFE-190-024



Beyer
WFE-190-025
18.0 cm / 7"



Zaufat-Janson
WFE-190-025
18.0 cm / 7"



Mayfield
WFE-190-027
17.0 cm / 6 3/4"



Marquardt
WFE-190-028
20.0 cm / 8"



Ruskin
WFE-190-029
18.0 cm / 7"



Ruskin
WFE-190-030
23.0 cm / 9"





Semb
WFE-191-001
22.5 cm / 9"



Stille
WFE-191-002
23.0 cm / 9"

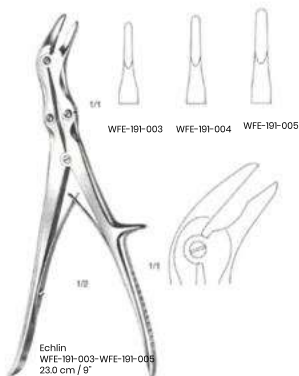

Echlin
WFE-191-003-WFE-191-005
23.0 cm / 9"



Stille Ruskin
WFE-191-006
23.0 cm / 9"



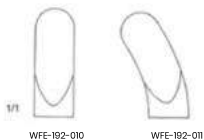
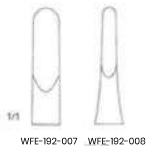

Leksoff-Stillie
WFE-192-007-WFE-192-008
24.0 cm / 9 1/2"



Frykholm
WFE-192-009
24.0 cm / 9 1/2"



Stille-Luer
WFE-192-010-WFE-192-011
22.0 cm / 8 3/4"



Bone Surgery Bone Rongeur Forceps

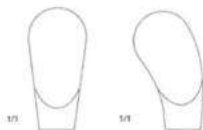

WFE-193-012 - 23.0 cm / 9"
WFE-193-013 - 27.0 cm / 10 1/2"

WFE-193-014 - 23.0 cm / 9"
WFE-193-015 - 27.0 cm / 10 1/2"

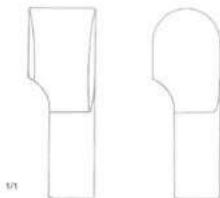

WFE-193-016

WFE-193-017



Stille-Luor
WFE-193-012 - WFE-193-015



Suerbruch
WFE-193-016 - WFE-193-017
30.0 cm / 12"





Markwalder
WFE-194-001
20.0 cm / 8"



Cottle-Kanzjian
WFE-194-002
19.0 cm / 7½"



WFE-194-003 14.0 cm / 5½"
WFE-194-004 17.0 cm / 6¾"

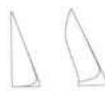

WFE-194-007 14.0 cm / 5½"
WFE-194-002 17.0 cm / 6¾"



Liston
WFE-194-003-WFE-194-006

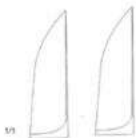

WFE-194-005 19.0 cm / 7½"
WFE-194-006 22.0 cm / 8¾"



Liston
WFE-194-007-WFE-194-010

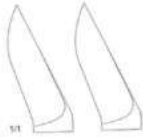

WFE-194-009 19.0 cm / 7½"
WFE-194-010 22.0 cm / 8¾"



Cleveland
WFE-195-011
17.0 cm / 6 3/4"



Cleveland
WFE-195-012
15.0 cm / 6"



WFE-195-013
12.0 cm / 4 3/4"

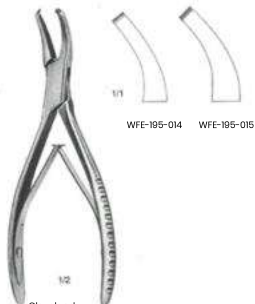

Cleveland
WFE-195-014-WFE-195-015
16.0 cm / 6 1/4"



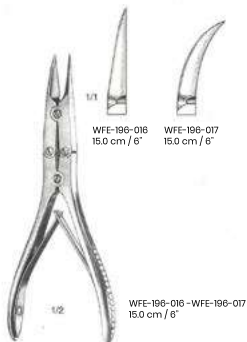

WFE-196-018
15.0 cm / 6"

Ruskin-Liston
WFE-196-019-WFE-196-020
18.5 cm / 7 1/4"



Bone Surgery Bone Cutting Forceps

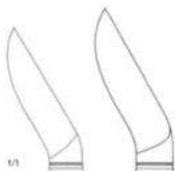

WFE-197-023
23.0 cm / 9 1/4"

WFE-197-024
27.0 cm / 10 5/8"



Stille-Liston
WFE-197-021
27.0 cm / 10 5/8"



Stille-Liston
WFE-197-022
27.0 cm / 10 5/8"



Liston-Key
WFE-197-023-WFE-197-024





Liston-Key
WFE-198-025
27.0 cm / 10 1/2"



Semb
WFE-198-026
24.0 cm / 9 1/2"



Bone Surgery Nail Instruments, Finger Ring Saws



Special Model
WFE-199-001
17.0 cm / 6 3/4"



Walton
WFE-199-003
18.0 cm / 6 3/4"



WFE-199-005
17.0 cm / 6 3/4"

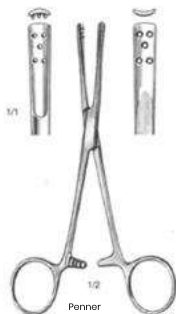

Pennner
WFE-199-007
15.5 cm / 6"



Radolf
WFE-199-008
13.5 cm / 5 1/4"



Bone Surgery Amputating and Resection Saws



Spare saw blade

WFE-200-004- 12.0 mm
WFE-200-005 - 15.0 mm



1/4

Charriere
WFE-200-003
35.0 cm / 14"



Spare saw blade

WFE-200-004- 3 mm
WFE-200-005 - 5 mm
WFE-200-006 - 7 mm



1/4

Hefferich-Bior
WFE-200-007
39.0 cm / 15 1/2"



1/2

Lindemann
WFE-200-008
20.0 cm / 8"



1/2

Langenbeck
WFE-200-009
23.0 cm / 9"



1/4

Charriere
WFE-200-010- 27 cm / 10 1/2"
WFE-200-010- 30 cm / 12"



1/4

Sattorie
WFE-200-012
31.0 cm / 12 1/4"





WFE-201-001
14.0cm / 5 1/2"



Perthes
WFE-201-002
20.0cm / 8 1/4"



WFE-201-003
14.0cm / 5 1/2"

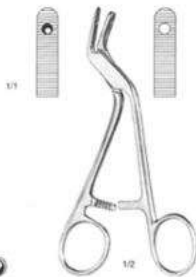

Adson
WFE-201-004
15.0cm / 6"





WFE-202-007
9 mm Ø



WFE-202-008
14 mm Ø



WFE-202-009
16 mm Ø



WFE-202-010
22 mm Ø



Hudson
WFE-202-005
27.0 cm / 10 1/8



Cushing
WFE-202-011
14 mm Ø



WFE-202-012
2 mm Ø



McKenzie
WFE-202-013
13 mm Ø



Eric
WFE-202-014
16 mm Ø

* Hand Drill, with 4 burrs fig. 7-10 and extension piece fig. 6



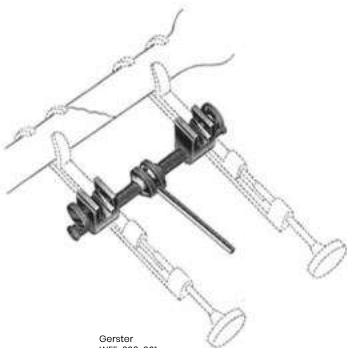

Gerster
WFE-203-001



1/1

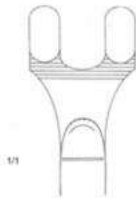

1/1

WFE-203-002
18.0 cm / 7"

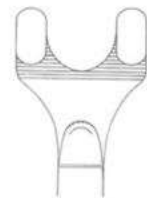

WFE-203-003
20.0 cm / 8"



Gerster-Lowmann
WFE-203-002WFE-203-004

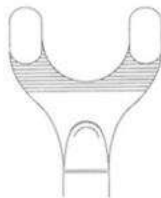

WFE-203-004
22.0 cm / 8 3/4"



Bone Surgery Flat Nose Pliers, Wire Cutting Pliers, Seizing Forceps



WFE-204-001
16.0 cm / 6 1/4"



WFE-204-002
16.0 cm / 6 1/4"



WFE-204-003
17.0 cm / 6 3/4"



WFE-204-004
18.0 cm / 7"

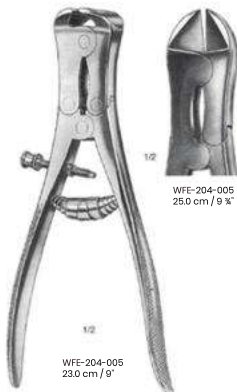

WFE-204-005
25.0 cm / 9 3/4"

WFE-204-005
23.0 cm / 9"

TUNGSTEN CARBIDE



WFE-204-007
15.0 cm / 6"



Bone Surgery Flat Nose Pliers



WFE-205-08

WFE-205-09

WFE-205-010



WFE-205-011

WFE-205-012

TUNGSTEN CARBIDE
GOLD PLATED



Parallel Action

WFE-205-008-WI-205-010
18.0 CM / 7"

1/2"

WFE-205-008-WI-205-012
18.0 CM / 7"



WFE-205-013
14.0 cm / 6 1/2"



WFE-205-014
16.0 cm / 6 1/4"

with groove



WFE-205-015-WFE-205-016
17.0 cm / 6 3/4"

WFE-205-015

WFE-205-016



Bone Surgery
Bone and Wire Cutting
Pliers Tungsten Carbide
Inserts



GOLD PLATED

WFE-206-002
 16.0 cm / 6 1/8"



Diamant
 WFE-206-002
 16.0 cm / 6 1/8"



for hard wires up to 1.6 mm Ø
 for soft wires up to 2.0 mm Ø

GOLD PLATED

WFE-206-003
 16.0 cm / 5 1/2"



for wires up to 2.5 mm Ø



WFE-206-004
 22.0 cm / 8 1/2"



Bone Surgery
Wire Cutting Pliers
Tungsten Carbide
Inserts



G O L D P L A T E D



WFE-207-005
15.0 cm / 6"



WFE-207-006
24.0 cm / 9 1/2"



WFE-207-007
18.0 cm / 7"



for soft wires
up to 2 mm Ø



for soft wires
up to 15 mm Ø





with 3 traction hooks

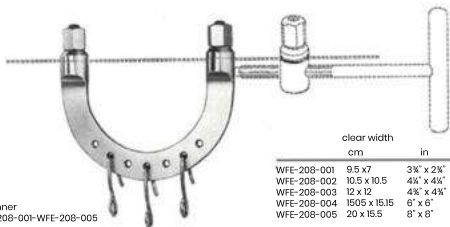

Kirschner
WFE-208-001-WFE-208-005

with 3 traction hooks

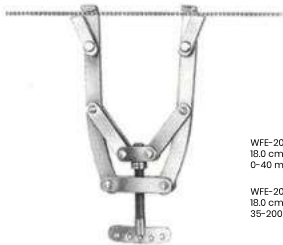

WFE-208-007
18.0 cm / 7 1/4"
0-40 mm

WFE-208-008
18.0 cm / 10 1/4"
35-200 mm

with 3 traction hooks



Kirschner
WFE-208-006
6 x 6 cm 2 1/2" x 2"

Kirschner
WFE-208-007-WFE-208-008



Bone Surgery Extension Bows



WFE-209-009



1/4

WFE-209-010
19.0 cm / 3/4"



WFE-209-011/WFE-209-012

	clear width	
	cm	in
WFE-209-011	18 x 10	7" x 4"
WFE-209-012	27 x 27	10 1/2" x 6 1/4"

Wire gauze, sterilizable



WFE-209-013
Small

WFE-209-014
Medium

WFE-209-015
Large

WFE-209-013-WFE-209_015

Fixation Disks for Wire Drills



1/1

WFE-209-016
Pair



1/1

WFE-209-017

1/1

WFE-209-018

- WFE-209-009 • Wire Strainer for Kirschner extension bows
- WFE-209-001-WFE-209_005
- WFE-209-010 • Screw Nut Wrench for
- WFE-209-001-WFE-209_005





WFE-210-001
14.0 cm / 5 1/2"



WFE-210-002 - 14.0 cm / 5 1/2"
WFE-210-003 - 16.0 cm / 6 1/4"



Turnbull
WFE-210-004 - 11 1/2 cm / 4 1/2"
WFE-210-005 - 13.0 cm / 5"

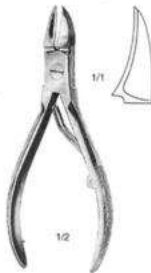

WFE-210-006
13.0 cm / 5"





WFE-211-007
12.0 cm / 4 3/4"



WFE-211-008 - 11.0 cm / 4 1/4"
WFE-211-009 - 13.0 cm / 5"
WFE-211-010 - 15.0 cm / 6"

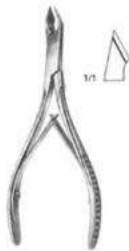

WFE-211-011 - 11.0 cm / 4 1/4"
WFE-211-012 - 13.0 cm / 5"

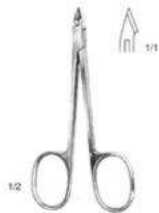

WFE-211-013
10.5 cm / 4 1/4"



Cohen
WFE-211-014
13.0 cm / 5"



Cohen
WFE-211-015
13.0 cm / 5"

Sterilization Iodine and Sterilizing Forceps



WFE-212-001
20.0 cm / 8"

*Iodine Forceps
of acrylic glass



Cheatie
WFE-212-002
27.0 cm / 10½"

*Sterilizing Forceps



WFE-212-003
30.0 cm / 12"



Rogge
WFE-212-004
23.0 cm / 9"



Pyo-Smith (Harrison)
WFE-212-005
30.0 cm / 12"



General Instruments Retractors



Graefo
WFE-213-001-WFE-213-002
16.0 cm / 6 1/4"



WFE-213-001
sharp



WFE-213-002
blunt



Graefo
WFE-213-003-WFE-213-006
16.0 cm / 6 1/4"



WFE-213-003



WFE-213-004



WFE-213-005



WFE-213-006



O'Connor
WFE-213-007
16.0 cm / 6 1/4"



Guthrie
WFE-213-006-WFE-213-009
16.0 cm / 6 1/4"



WFE-213-008

WFE-213-009



General Instruments Retractors

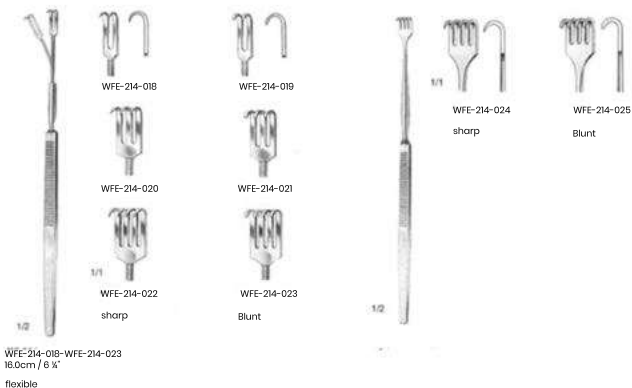
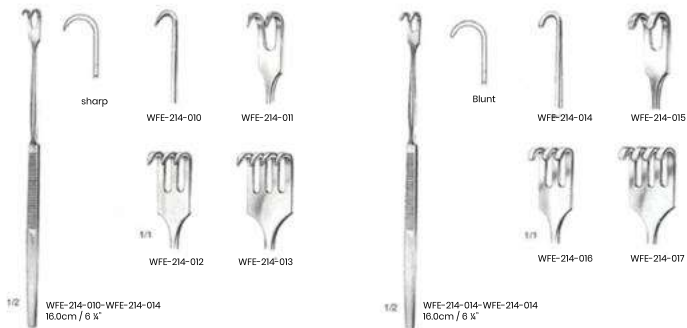



WFE-215-001
12.0 cm / 4 1/2"

*Micro retractor with saddle blade, buttoned



Desmarros
WFE-215-002-WFE-215-007
16.0cm / 6 1/4"



WFE-215-008-WFE-215-011
16.0cm / 6 1/4"



Mini-Langenbeck
WFE-215-012-WFE-215-015
16.0cm / 6 1/4"



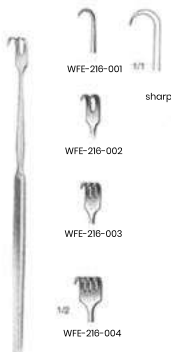

WFE-216-001-WFE-216-004
16.0 cm / 6 1/4"

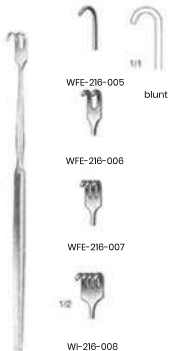

WI-216-005-WI-216-008
16.0 cm / 6 1/4"

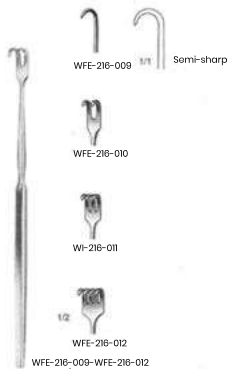

WFE-216-009-WFE-216-012
16.0 cm / 6 1/4"

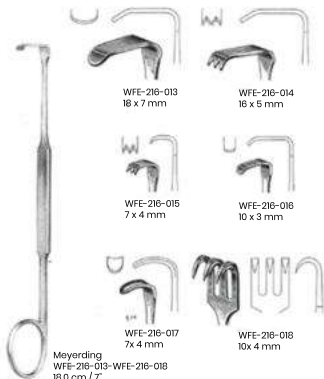

Meyering
WFE-216-013-WFE-216-018
18.0 cm / 7"



General Instruments Retractors

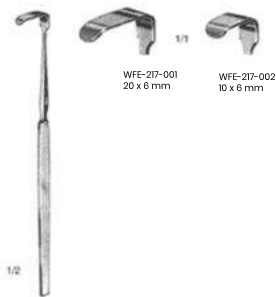

WFE-217-001
20 x 6 mm

WFE-217-002
10 x 6 mm

Senn-Green
WFE-217-001-WFE-217-002
15.0 cm / 6"



8 x 4 mm

15 x 5.5 mm

Ragnell-Davis
WFE-217-003
14.0 cm / 5 1/2"

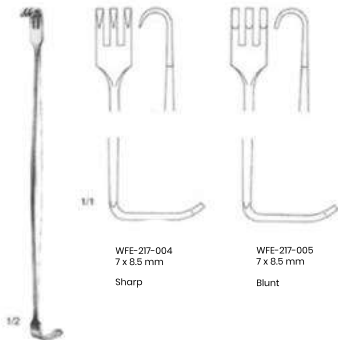

WFE-217-004
7 x 8.5 mm

Sharp

WFE-217-005
7 x 8.5 mm

Blunt

Senn-Mueller
WFE-217-004-WFE-217-005
16.0 cm / 6 1/4"



Cushing
WFE-217-006
20.0 cm / 8"



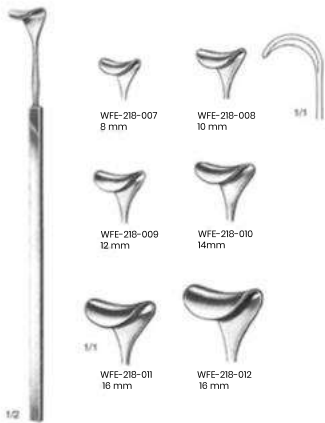

Cushing
WFE-218-007-WFE-218-012
20.0 cm . 8"

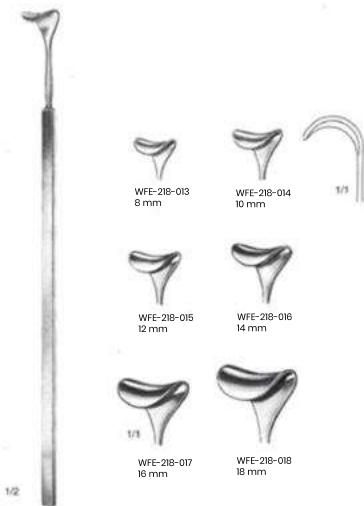

Cushing
WFE-218-013-WFE-218-018
24.0 cm . 9 1/2"





WFE-219-001



WFE-219-002

Venenhaken Bron
WFE-219-001-WFE-219-002
19.0 cm / 7 1/2"



WFE-219-003



WFE-219-004
toothed

Strandell-Stille
WFE-219-003-WFE-219-004
19.0 cm / 7 1/2"



sharp

1/1

WFE-219-005



WFE-219-006



WFE-219-007



WFE-219-008

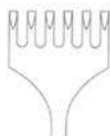

WFE-219-009



blunt

WFE-219-010



WFE-219-011



WFE-219-012



WFE-219-013

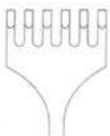

WFE-219-014

Volkman
WFE-219-005-WFE-219-014
23.0 cm / 9"

1/1



General Instruments Retractors



WFE-221-001 WFE-221-002 WFE-221-003 WFE-221-004 WFE-221-005 WFE-221-006

sharp



WFE-221-007 WFE-221-008 WFE-221-009 WFE-221-010 WFE-221-011 WFE-221-012

blunt



WFE-221-013 WFE-221-014 WFE-221-015 WFE-221-016 WFE-221-017 WFE-221-018

semi-sharp



Kocher
WFE-221-001-WFE-221-018
22.0 cm / 8 3/4"



General Instruments Retractors

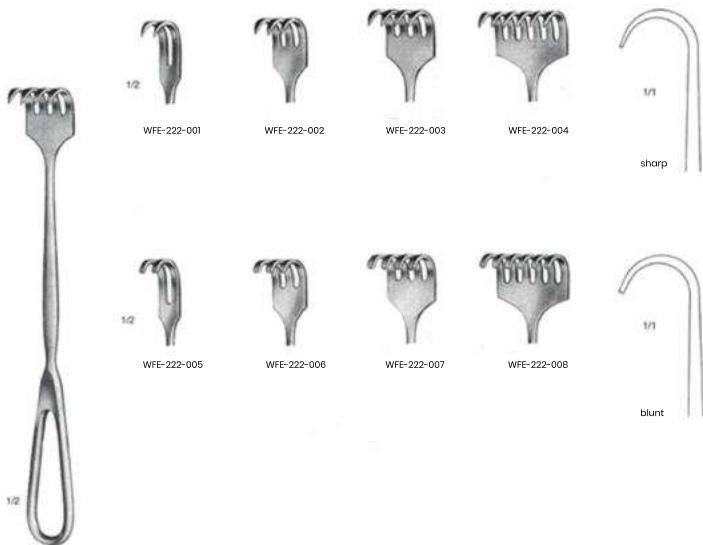

Special Model
WFE-222-001-WFE-22-08
22.0 cm / 8 3/4"





WFE-223-002
36 x 60 mm

33 x 20 mm

WFE-223-005
40 x 30 mm
blunt

WFE-223-004
40 x 30 mm
sharp



WFE223-001
36 x 30 mm

Ollier
WFE-223-001-WI-223-002
22.5 cm / 9"

Wassmund
WFE-223-003
20.0 cm / 8"

Koerte
WFE-223-004-WFE-223-005
23.5 cm / 9 1/4"





WF-224-006
40 x 40 mm



WFE-224-007
45 x 50 mm



WFE-224-008
50 x 60 mm

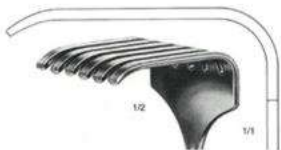

WFE-224-009
70 x 70 mm



1/2

Israel
WFE-224-006-WFE-224-009
25.0 cm / 10"





1/2

Langenbeck
WFE-225-WFE-225-005
22.0 cm / 8½"



1/2

Langenbeck
WFE-225-WFE-225-010
21.0 cm / 8¼"



WFE-225-001
WFE-225-008
30 x 11 mm



WFE-225-002
WFE-225-007
30 x 17 mm



WFE-225-003
WFE-225-008
30 x 16 mm



WFE-225-004
WFE-225-009
40 x 11 mm



1/1

WFE-225-005
WFE-225-010
50 x 11 mm





60 x 20 mm

1/1

1/2

Langenbeck
WFE-226-01
21.0 cm / 8 1/4"

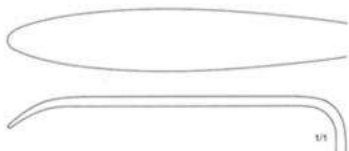

1/1

85 x 15 mm

1/2

Langenbeck
WFE-226-02
21.0 cm / 8 1/4"





1/2

Kocher
WFE-227-013- WFE-227-017
23.0 cm / 9"



WFE-227-013
40 x 18 mm



WFE-227-014
60 x 20 mm



WFE-227-015
60 x 25 mm



WFE-227-016
75 x 30 mm



1/3

WFE-227-017
75 x 40 mm





1/2

Kocher-Langenbeck
WFE-228-018-WFE-228-026
21.5 cm / 8 1/2"



WFE-228-018
26 x 6 mm



WFE-228-019
35 x 8 mm



WFE-228-020
35 x 11 mm



WFE-228-021
35 x 15 mm



WFE-228-022
40 x 11 mm



WFE-228-023
50 x 11 mm



WFE-228-024
70 x 14 mm



WFE-228-025
80 x 12 mm



WFE-228-026
80 x 16 mm





49 x 38 mm
28 x 20 mm



35 x 28 mm
71 x 43 mm

Richardson-Eastmann
WFE-229-001 - set of two (2-3)
WFE-229-002 - Fig 1 - 26.0 cm / 10 1/8"
WFE-229-003 - Fig 2 - 28.0 cm / 11"



WFE-229-004
28 x 20 mm



WFE-229-005
36 x 28 mm



WFE-229-006
44x 38 mm



Richardson
WFE-229-004-WFE-29-005
24.0 cm / 9 1/2"



52 x 22 mm

Richardson
WFE-229-007
24.0 cm / 9 1/2"



65 x 50 mm

Kelly
WFE-229-08
26.0 cm / 10 1/4"





50 x 85 mm

1/2

Doyen
WFE-230-001
25.0 cm / 10"



1/2

Doyen
WFE-230-002
25.0 cm / 10"



70 x 25 mm

1/2

Kocher
WFE-230-003
22.5 cm / 9"



1/2

Kocher
WFE-230-004-WI-230-006
25.0 cm / 10"

WFE-230-004- 80 x 45 mm
WFE-230-005- 80 x 55 mm
WFE-230-006- 80 x 65 mm



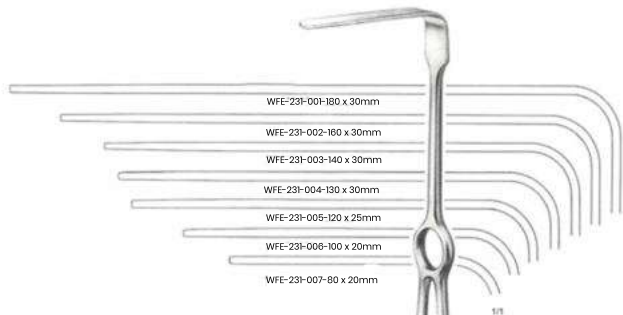

Brunner
WFE-231-001-WFE-231-007
25 cm / 10"

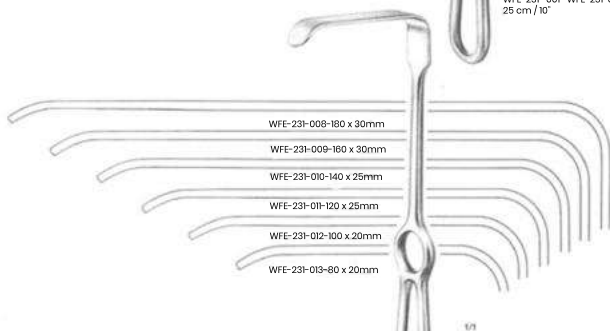

Brunner
WF-231-008-WF-231-013
25 cm / 10"





WFE-232-001

127 x 40 mm

WFE-232-002

127 x 62 mm

Harrington
WFE-232-001 - WFE-232-002
32.0 cm / 12 1/2"







38 mm

1/2

Deaver
WFE-234-007
30.0 cm / 12"



50 mm

1/2

Deaver
WFE-234-008
30.0 cm / 12"



75 mm

1/2

Deaver
WFE-234-009
30.0 cm / 12"





25 mm
WFE-235-010



1/2

Deaver
WI-235-010-WFE-235-013
31.0 cm / 12 1/4"



38 mm
WFE-235-011



50 mm
WFE-235-012

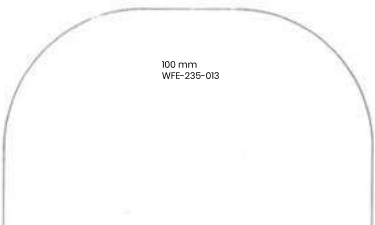

100 mm
WFE-235-013

1/1



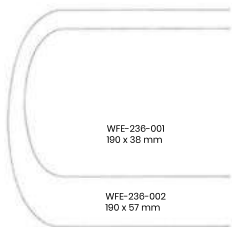

WFE-236-001
190 x 38 mm

WFE-236-002
190 x 57 mm



Kelly
WFE-236-001-WFE-236-02
27.0 cm / 10 1/2"

1/2



5/1

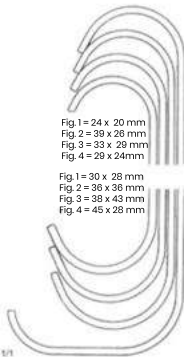

Fig. 1 = 24 x 20 mm
Fig. 2 = 39 x 26 mm
Fig. 3 = 33 x 29 mm
Fig. 4 = 29 x 24mm

Fig. 1 = 30 x 28 mm
Fig. 2 = 36 x 36 mm
Fig. 3 = 38 x 43 mm
Fig. 4 = 45 x 28 mm

Roux
WFE-236-003-set of three-fig.1-3)
WFE-236-004-Fig.1 = 14.0 cm / 5 1/2"
WFE-236-005-Fig. 2 = 15.0 cm / 6"
WFE-236-006-Fig. 3 = 17.0 cm / 6 3/4"
WFE-236-007-Fig. 4 = 18.0 cm / 7"





Fig. 1 = 30 x 10 mm
Fig. 2 = 26 x 10 mm

Fig. 1 = 30 x 13 mm
Fig. 2 = 34 x 13 mm

Farabeuf
WFE-237-008 - set of two
12.0 cm / 4 3/4"



Fig. 1 = 27 x 16 mm
Fig. 2 = 23 x 16 mm

Fig. 1 = 26 x 16 mm
Fig. 2 = 30 x 16 mm

Farabeuf
WFE-237-009 - set of two
15.0 cm / 6"



Mini-Roux
WFE-237-010
14.0 cm / 5 1/2"

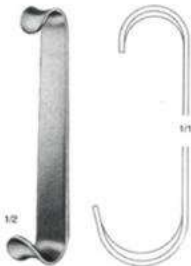

Baby-Roux
WFE-237-011
13.5 cm / 5 1/4"

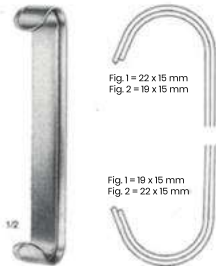

Fig. 1 = 22 x 15 mm
Fig. 2 = 19 x 15 mm

Fig. 1 = 19 x 15 mm
Fig. 2 = 22 x 15 mm

Parker
WFE-237-012 - set of two
13.5 cm / 5 1/4"





Fig. 1 = 26 x 25 mm
Fig. 2 = 29 x 25 mm

1/2

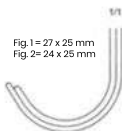

Fig. 1 = 27 x 25 mm
Fig. 2 = 24 x 25 mm

1/1

Parker
WFE-238-013-Set of two
18.0 cm / 7"



1/2

Parker-Mott
WFE-238-014-Set of two
16.0 cm / 6 3/4"



Fig. 2 = 25 x 24 mm
Fig. 1 = 21 x 24 mm

1/1

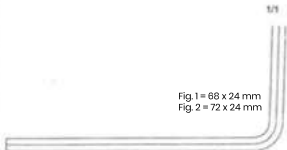
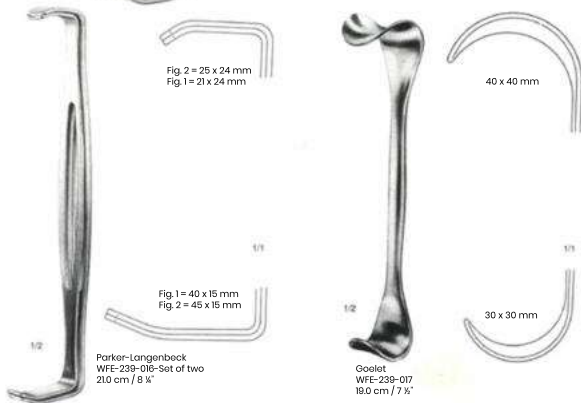
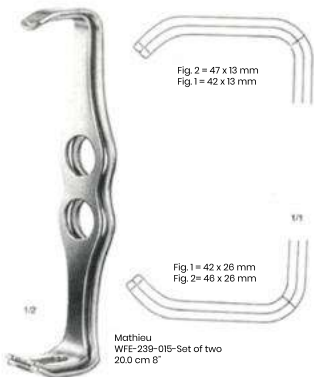

Fig. 1 = 68 x 24 mm
Fig. 2 = 72 x 24 mm







Finson
WFE-240-001-WFE-240-004
7.0 cm / 2"
3 x 4 teeth



WFE-240-001
Sharp



WFE-240-002
Blunt



WFE-240-003
Sharp



WFE-240-004
Blunt



Special Model
WFE-240-005-WFE-240-008
7.0 cm / 2 3/4"
3 x 4 teeth



WFE-240-005
sharp



WFE-240-006
blunt



Logan
WFE-240-007
4.0 cm / 1 1/2"
3 x 3 teeth





Buckley
WFE-241-008
6.0 cm / 2 3/8"
3 x 3 teeth
Sharp



WFE-241-009
8.0 cm / 3 1/4"
3 x 3 teeth



WFE-241-010
10.0 cm / 4"
4 x 4 teeth
Blunt



Alm
WFE-241-011-WFE-241-015
4 x 4 teeth



WFE-241-011-7.0 cm / 2 3/4"
Sharp



WFE-241-012-10.0 cm / 4"
Sharp



WFE-241-013-7.0 cm / 2 3/4"
Blunt



WFE-241-014-10.0 cm / 4"
Semi-Sharp



WFE-241-015-10.0 cm / 4"
Blunt



Jansen
WFE-242-016-WFE-242-018
10.0 cm / 4"
3 x 3 teeth



WFE-242-016
Sharp

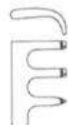

WFE-242-017
with 1 Sharp and 2 blunt prongs each



WFE-242-018
Blunt



Scalp Contour
WFE-242-019-WFE-242-020
14.0 cm / 5 1/2"
3 x 4 teeth

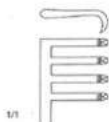

WFE-242-019
Sharp

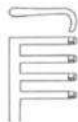

WFE-242-020
blunt





90 mm

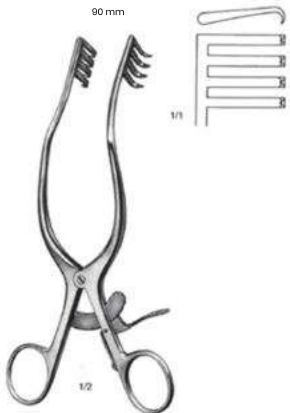

Anderson-Adson
WFE-243-001
19.5 cm / 7 3/4"
4 x 4 teeth

80 mm

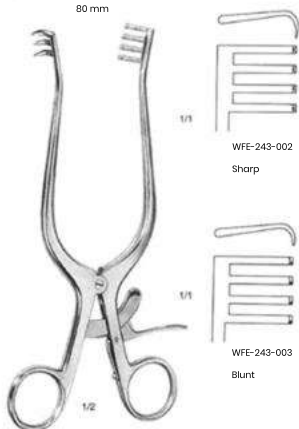

Weltlaner
WFE-243-002-WFE-243-003
20.0 cm / 8"

WFE-243-002

Sharp

WFE-243-003

Blunt





80 mm



Adson
WFE-244-004-WFE-244-007
28.0 cm / 10 1/2"

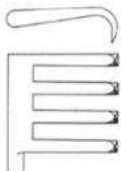

WFE-244-004
3 x 4 teeth
sharp

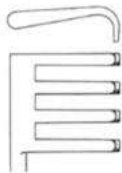

WFE-244-005
3 x 4 teeth
blunt

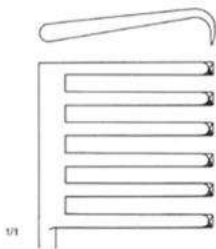

WFE-244-006
6 x 6 teeth
sharp

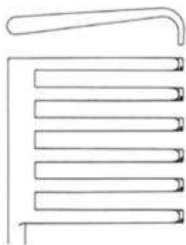

WFE-244-007
3 x 4 teeth
blunt





<p>35mm</p> <p>1/2</p>		<p>WFE-245-008 2 x 3 teeth Sharp</p>	<p>5 mm 80 mm</p> <p>1/2</p>		<p>WFE-245-010-13.0 cm / 5" 3 x 4 teeth Sharp</p>		<p>WFE-245-012-16.5 cm / 6 1/2" 3 x 4 teeth Sharp</p>
<p>Weltlaner-Loktite WFE-245-008-WFE-245-009 10.5 cm / 4 1/4"</p>		<p>WFE-245-009 2 x 3 teeth blunt</p>		<p>WFE-245-011-13.0 cm / 5" 3 x 4 teeth blunt</p>		<p>WFE-245-013-16.5 cm / 6 1/2" 3 x 4 teeth blunt</p>	
<p>50 mm</p> <p>1/2</p>		<p>WFE-245-014 Sharp</p>	<p>1/2</p>		<p>sharp</p>		
<p>Weltlaner-Wullstein WFE-245-014-WFE-245-015 13.0 cm / 5"</p>		<p>WFE-245-015 blunt</p>	<p>Millison WFE-245-016 15.0 cm / 6"</p>				

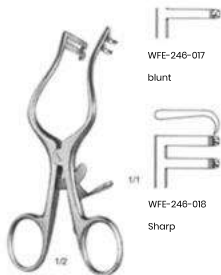

Plester
WFE-246-017-WFE-246-018
13.0 cm / 5"
2 x 2 teeth

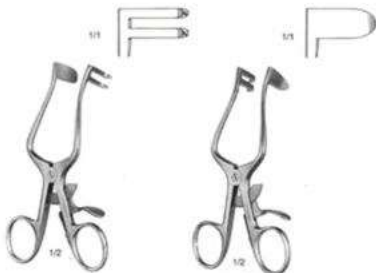

Plester
WFE-246-019
11.0 cm / 4 1/4"
2 teeth
blunt

Plester
WFE-246-020
11.0 cm / 4 1/4"
2 teeth
blunt

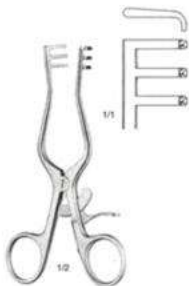

Milligan
WFE-246-021
13.0 cm / 5"

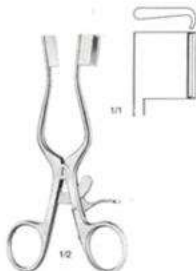

Weltliner-Baby
WFE-246-022
13.0 cm / 5"

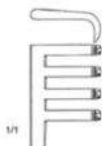

WFE-247-001
Sharp

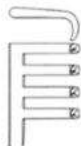

WFE-247-002
Blunt



Honley
WFE-247-001-WFE-247-002
16.5cm / 6 1/2"
3 x 4 teeth



WFE-247-003
16mm x 19 mm
3/4" x 3/4"



WFE-247-004
16mm x 25 mm
3/4" x 1"



WFE-247-005
16mm x 32 mm
3/4" x 1 1/4"





Adson
WFE-248-001- WFE-248-008
3 x 4 teeth



WFE-248-001
13.0 cm / 5"



WFE-248-002
13.0 cm / 5"



WFE-248-003
16.0 cm / 6 1/4"



WFE-248-004
16.0 cm / 6 1/4"



WFE-248-005
20.0 cm / 8"



WFE-248-006
20.0 cm / 8"

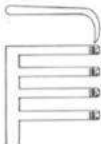

WFE-248-007
26.0 cm / 10 1/4"
sharp



WFE-248-008
26.0 cm / 10 1/4"
Blunt





E X C H A N G E B L A D E S



Cloward
WFE-249-001 Retractor without blades
25.0 cm / 10"
WFE-249-002 Retractor complete with two blades
25.0 cm / 10"





Beckmann
WFE-250-001
31.0 cm 12 1/4"
4 x 4 teeth

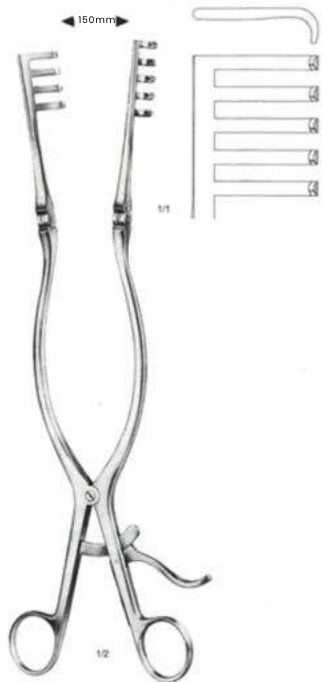

Adson
WFE-250-002
32.0 cm 12 1/2"
4 x 5 teeth





Beckmann-Adson
WFE-251-03 - WFE-251-06
31.0 cm / 12 1/4"
4 x 4 teeth

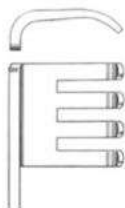

WFE-251-003

blunt



WFE-251-004

blunt



1/1

WFE-251-005

sharp



WFE-251-006

sharp



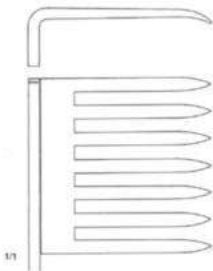

Beckmann-Eaton
WFE-252-007
32.0 cm / 12 1/2"





Hemi-Laminectomy
WFE-253-008 - WFE-253-009
270 cm / 10 5/8"
6 x 6 teeth

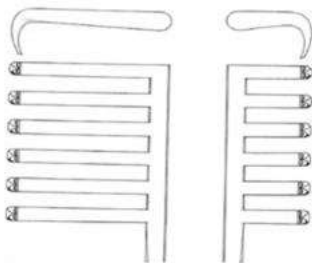

WFE-253-008

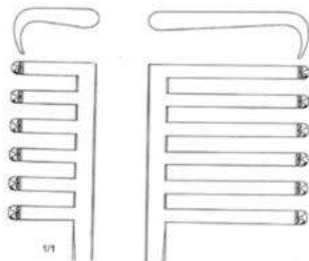

WFE-253-009



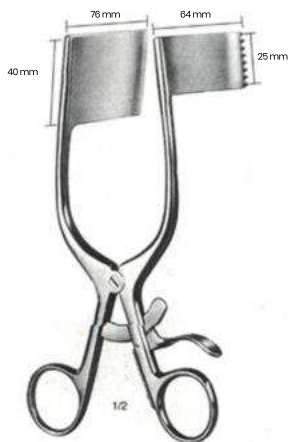

Darling
WFE-254-010
18.0 cm / 7"
(Paplitea)

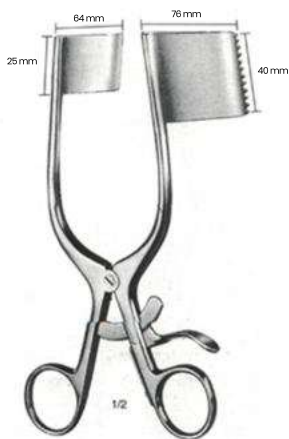

Darling
WFE-254-011
18.0 cm / 7"
(Paplitea)



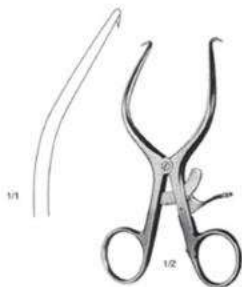

Gelpi-Loktite
WFE-255-012
13.0 cm / 5"

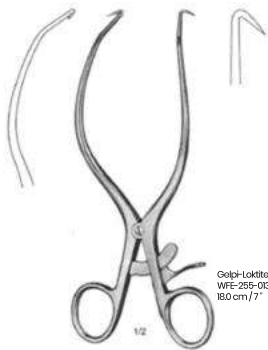

Gelpi-Loktite
WFE-255-013
18.0 cm / 7"



Gelpi-Loktite
WFE-255-014
18.0 cm / 7"



Gelpi-Loktite
WFE-255-015
15.0 cm / 6"





E X C H A N G A B L E B L A D E S

Measurements of blades: Depth x width

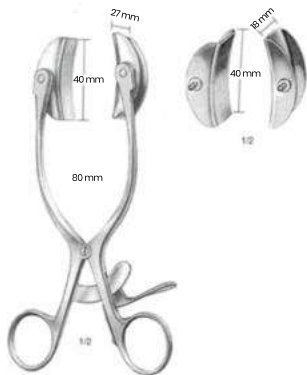

Baby-Collin
WFE-256-001

complete, with 2 pairs of blades



Collin
WFE-256-002

complete, with 1 pair of blades 38 x 60 mm



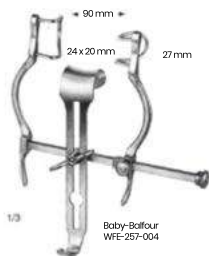
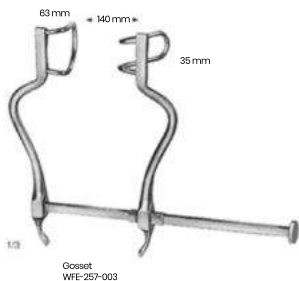
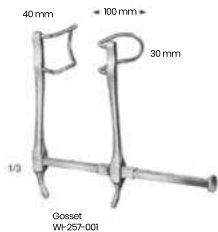

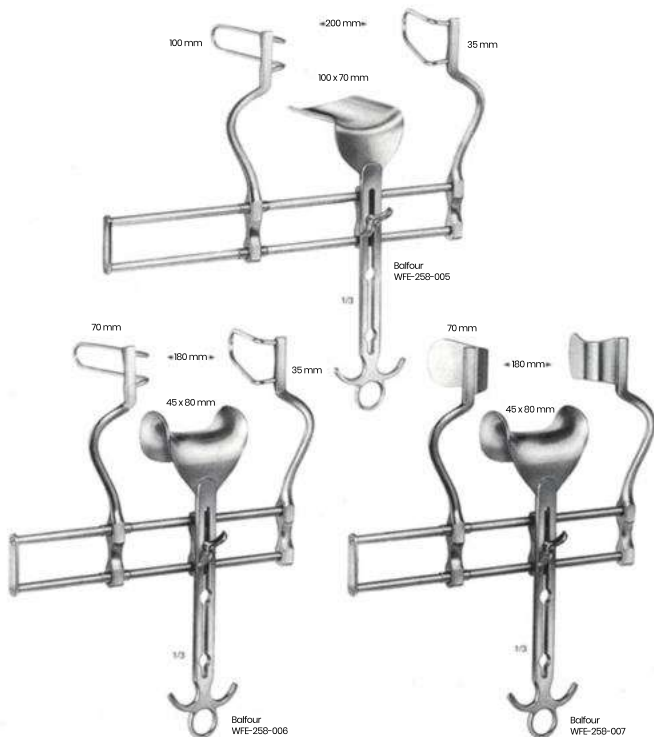

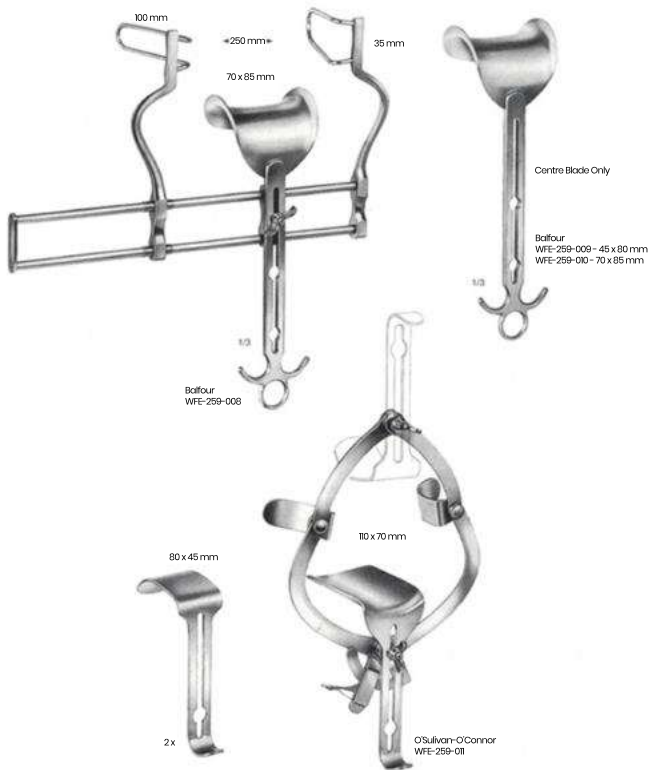



Reverdin
WFE-260-001
28.0 cm / 11"



Ribbon
WFE-260-002 - 33.0 cm / 13", 30 mm
WFE-260-003 - 33.0 cm / 13", 40 mm
WFE-260-004 - 33.0 cm / 13", 50 mm

flexible



Haberer
WFE-260-005 - 20.0 cm / 8", 17/25 mm
WFE-260-006 - 28.0 cm / 11", 25/30 mm
WFE-260-007 - 30.0 cm / 12", 37/45 mm

flexibles



Special Model Soft
WFE-260-008 - 20.0 cm x 12 mm
WFE-260-009 - 20.0 cm x 17 mm
WFE-260-010 - 25.0 cm x 25 mm

maleable and very soft

WFE-260-011 - 20.0 cm x 6.5 mm
WFE-260-012 - 20.0 cm x 9.5 mm
WFE-260-013 - 20.0 cm x 13 mm
WFE-260-014 - 20.0 cm x 16 mm
WFE-260-015 - 20.0 cm x 19 mm
WFE-260-016 - 20.0 cm x 25 mm





WFE-261-001

WFE-261-002

WFE-261-003



WFE-261-004

WFE-261-005

WFE-261-006



Goldsmith (Thudichum)
WFE-261-001 - WFE-261-003



Voltoini
WFE-261-004 - WFE-261-006



Schwarz
WFE-261-007
14.0 cm / 5 1/2"



Hartmann-Halle
WFE-261-008 - WFE-261-010
15.0 cm / 6"

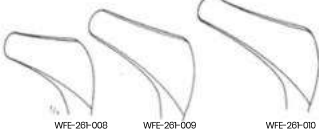

WFE-261-008

WFE-261-009

WFE-261-010



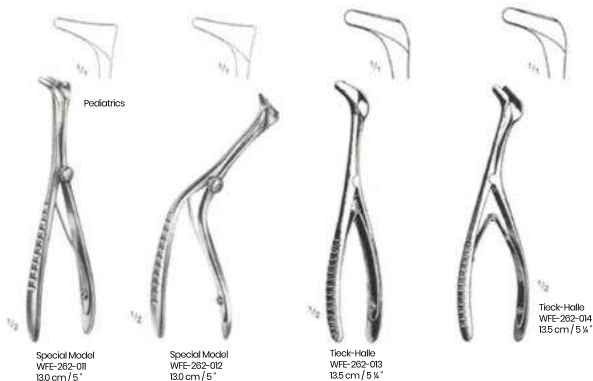

Tick-Halle
WFE-262-014
13.5 cm / 5 1/4"

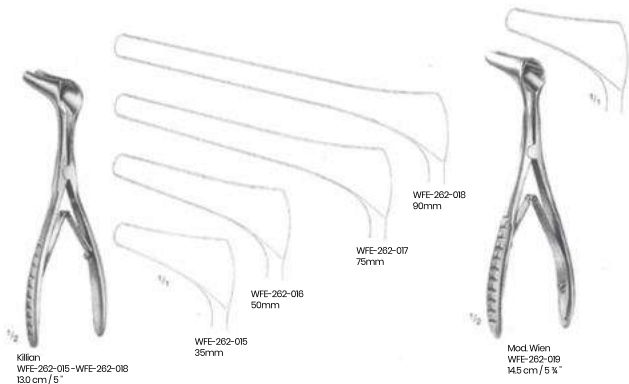



Cottle
WFE-263-020-WFE-263-023
15.0 cm / 6"

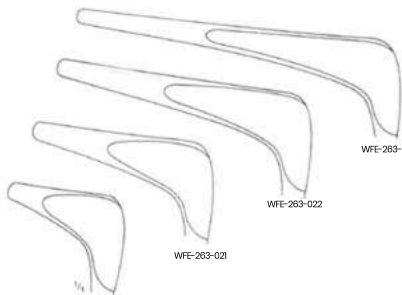

WFE-263-023

WFE-263-022

WFE-263-021

WFE-263-020



Cottle
WFE-263-024-WFE-263-025
14.0 cm / 5 1/2"

Dull black
chromium
plated

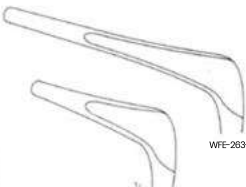

WFE-263-025

WFE-263-024



Yankauer
WFE-263-026
13.0 cm / 7 1/4"





Troeltsch
WFE-284-001
15.0cm / 6"

Troeltsch
WFE-284-002
18.0cm / 7"



Gruenwald (Jansen)
WFE-284-003
20.0cm / 8"



Westmacott
WFE-284-005
20.0cm / 8"

Lubet-Barbon
WFE-284-006
20.0cm / 8"

Hartmann
WFE-284-007
18.0cm / 7"

Heymann
WFE-284-008
18.0cm / 7"





Hartmann
WFE-265-008
20.0 cm / 8"



Littauer
WFE-265-009
18.0 cm / 7"



Kilian
WFE-265-010
17.0 cm / 6 1/2"



WFE-265-012



WFE-265-013



WFE-265-014



Quire
WFE-265-011
12.0 cm / 4 1/2"



Heymann
WFE-265-012 - WFE-265-014
18.0 cm / 7"



Knight
WFE-265-015
18.0 cm / 7"





Craig
WFE-266-016
13.0cm / 7"



WFE-266-017 WFE-266-018
13.0cm / 7"



Luc
WFE-266-019 - WFE-266-020
20.0cm / 8"



WFE-266-021 WFE-266-022

Luc
WFE-266-021 - WFE-266-022
20.0cm / 8"

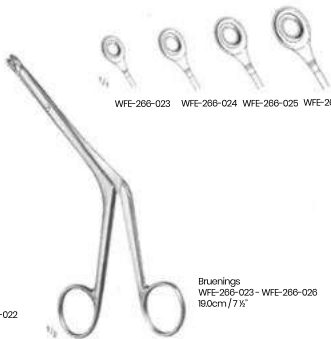

WFE-266-023 WFE-266-024 WFE-266-025 WFE-266-026

Bruonings
WFE-266-023 - WFE-266-026
19.0cm / 7½"



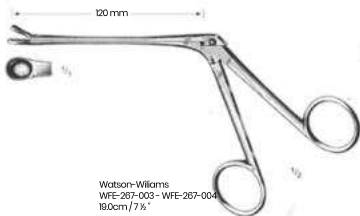
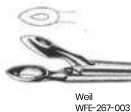

Rhinology Nasal Cutting Forceps



without neck



WI-268-005



WI-268-006



WI-268-007



WI-268-008



WI-268-009



with neck



WFE-268-010



WFE-268-011



WFE-268-012



WFE-268-013



WFE-268-014

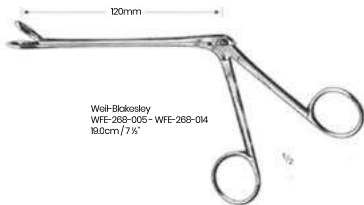

Well-Blokosloy
WFE-268-005 - WFE-268-014
18.0cm / 7 1/8"

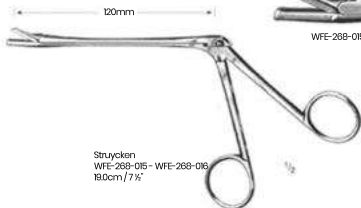

Struycken
WFE-268-015 - WFE-268-016
18.0cm / 7 1/8"



WFE-268-015



WFE-268-016





WFE-269-017
2.2mm

WFE-269-018
2.6mm

WFE-269-019
3.0mm

WFE-269-020
3.4mm

WFE-269-021

WFE-269-022

WFE-269-023



120mm

WFE-269-017 - WFE-269-020

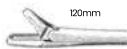

120mm

Myles
WFE-269-021 - WFE-269-023
18.0cm / 7 1/8"

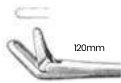

120mm

Hojek
WFE-269-024
18.0cm / 7 1/8"

WFE-269-025
5.0mm

WFE-269-026
7.0mm

WFE-269-027
9.0mm

WFE-269-028
11.0mm



120mm

Hartman
WFE-269-025 - WFE-269-028
18.0cm / 7 1/8"



120mm

Schmeden
WFE-269-029
18.0cm / 7 1/8"



120mm





Jansen-Struycken
WFE-270-001
18.0cm/7 1/8"



Middleton-Jansen
WFE-270-002
18.0cm/7 1/8"



Middleton-Jansen
WFE-270-003
18.0cm/7 1/8"





Caplan
WFE-27H-004
20.0cm / 8"

Septumscissors serrated



Kilian
WFE-27H-005
21.0cm / 8 1/2"

Septumscissors serrated



Rubin
WFE-27H-006
21.0cm / 8 1/2"

Septum morselizer



W-27H-007





4 x 4mm Hajak WFE-272-001

4 x 4mm Hajak WFE-272-002

3.5 x 3.5mm Hajak-Kofler WFE-272-003

3.5 x 3.5mm Hajak-Kofler WFE-272-004

3 x 5mm WFE-272-005

3 x 5mm WFE-272-006

5 x 5mm WFE-272-007

5 x 5mm WFE-272-008

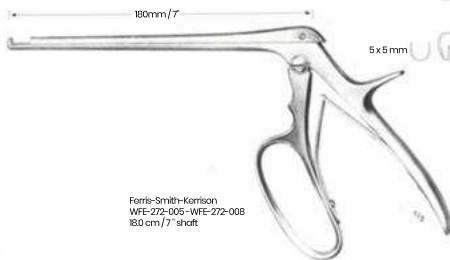

Rhinology Sphenoid Punches and Rongeur Forceps

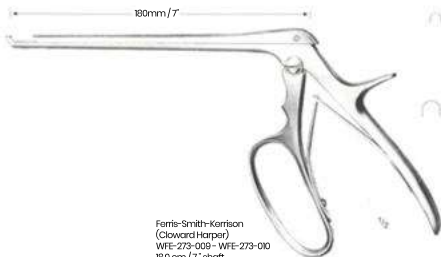

Ferris-Smith-Kerrison
(Cloward Harper)
WFE-273-009 - WFE-273-010
18.0 cm / 7" shaft



WFE-273-009 = 3 mm

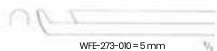

WFE-273-010 = 5 mm

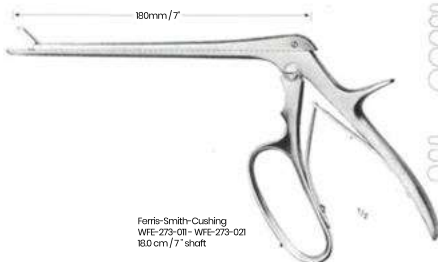

Ferris-Smith-Cushing
WFE-273-011 - WFE-273-021
18.0 cm / 7" shaft



curved up

WFE-273-011 = 2 x 10 mm

WFE-273-012 = 3 x 10 mm

WFE-273-013 = 4 x 10 mm



straight

WFE-273-014 = 2 x 10 mm

WFE-273-015 = 3 x 10 mm

WFE-273-016 = 4 x 10 mm

WFE-273-017 = 5 x 10 mm

WFE-273-018 = 6 x 10 mm

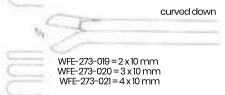

curved down

WFE-273-019 = 2 x 10 mm

WFE-273-020 = 3 x 10 mm

WFE-273-021 = 4 x 10 mm



Rhinology Sphenoid Punches, Antrum Punch Forceps



4 x 4 mm  WFE-274-023 = 4 mm

5 x 5 mm  WFE-274-024 = 5 mm

6 x 6 mm  WFE-274-025 = 6 mm



Hajeck-Claus
WFE-274-022
20.0cm / 8"



Kerrison
WFE-274-023 - WFE-274-025
20.0cm / 8"





Joseph
WFE-275-001 - WFE-275-004



WFE-275-001



WFE-275-002

Straight



WFE-275-003



WFE-275-004

Curved



Forman
WFE-275-005
16.0 cm / 6 1/4"



Converse
WFE-275-006
16.0 cm / 6 1/4"



Joseph
WFE-275-007
15.0 cm / 6"



Cottle
WFE-275-008
15.0 cm / 6"



Cottle
WFE-275-009
15.0 cm / 6"





Joseph
WFE-275-001-WFE-275-004



WFE-275-001



WFE-275-002

Straight



WFE-275-003



WFE-275-004

Curved



Forman
WFE-275-005
16.0 cm / 6 1/4"



Converse
WFE-275-006
16.0 cm / 6 1/4"



Joseph
WFE-275-007
15.0 cm / 6"



Cottle
WFE-275-008
15.0 cm / 6"



Cottle
WFE-275-009
15.0 cm / 6"





WFE-277-001
4 mm



WFE-277-002
5 mm



McKenty
WFE-277-001-WFE-277-002



Halle
WFE-277-003
16.5 cm / 6 1/2"



Joseph
WFE-277-004
16.5 cm / 6 1/2"



Frøer
WFE-277-005
19.0 cm / 7 1/2"

sharp



Frøer
WFE-277-006
19.0 cm / 7 1/2"

blunt



Frøer
WFE-277-007
18.0 cm / 7"

sharp-blunt



sharp

blunt

Frøer
WFE-277-008
20.5 cm / 8"





McKenty
WFE-278-009
22.0 cm / 8 1/4"

Cottle
WFE-278-010
23.0 cm / 9"

Kilian
WFE-278-011
18.0 cm / 7"

Kilian
WFE-278-012
22.0 cm / 8 1/2"

Pierce
WFE-278-013
21.0 cm / 8 1/4"

Pennington
WFE-278-014
21.0 cm / 8 1/4"

Rogor
WFE-278-015
18.0 cm / 7 1/4"





Carter
WFE-279-016
21.0 cm / 8 1/4"



Joseph-Masing
WFE-279-017
22.0 cm / 8 1/2"



Cottle
WFE-279-018
22.0 cm / 78 1/4"



Masing
WFE-279-019
21.0 cm / 8 1/4"



Cottle
WFE-279-020
21.0 cm / 8 1/4"



Joseph
WFE-279-021
18.0 cm / 6 1/4"



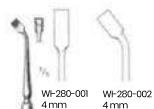

Freer
W-280-001 - W-280-002
19.0 cm / 7 1/2"



Freer
W-280-003
4 mm

Freer
W-280-004
4 mm



Freer
W-280-005
6 mm

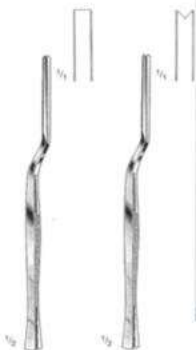

Kilian
W-280-006
5 mm
17.0 cm / 6 3/4"

Kilian-Claus
W-280-007
5 mm
17.0 cm / 6 3/4"

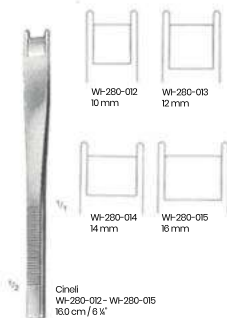
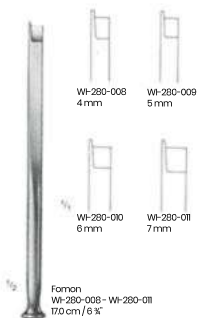

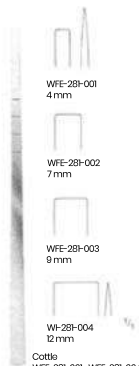

Cottle
WFE-281-001-WFE-281-004
18.0 cm / 7"



Cottle
WFE-281-005
18.0 cm / 7"

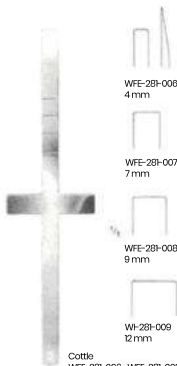

Cottle
WFE-281-006-WFE-281-009
18.0 cm / 7"



Cottle
WFE-281-010
18.0 cm / 7"



Cottle
WFE-281-011
18.0 cm / 7"



Cottle
WFE-281-012
18.0 cm / 7"





Sheehan
WFE-282-001-WFE-282-004
17.0 cm / 6 3/4"



WFE-282-001
7 mm



WFE-282-002
8 mm



WFE-282-003
10 mm



WFE-282-004
12 mm



W-282-005

Silver
WFE-282-005-WFE-282-007
18.0 cm / 7"



WFE-282-006



WFE-282-007



Joseph
WFE-282-008-WFE-282-009
17.0 cm / 6 3/4"

WFE-282-008

WFE-282-009



Joseph
WFE-282-010-WFE-282-012
19.0 cm / 6 3/4"



WFE-282-010



WFE-282-011



WFE-282-012





Maltz
WFE-283-001
18.0 cm / 7"



Joseph
WFE-283-002
18.0 cm / 6 3/4"



Gallagher
WFE-283-003 - WFE-283-005
18.0 cm / 6 3/4"



WFE-283-003



WFE-283-004

WFE-283-005



Cottle
WFE-283-006
21.0 cm / 8 1/4"

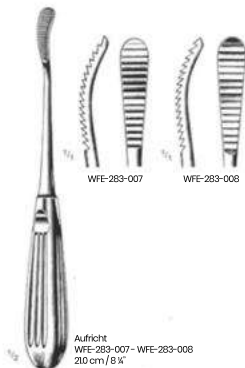

WFE-283-007

WFE-283-008

Aufrecht
WFE-283-007 - WFE-283-008
21.0 cm / 8 1/4"

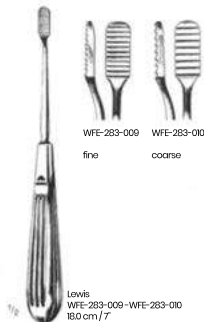

WFE-283-009

WFE-283-010

fine

coarse

Lewis
WFE-283-009 - WFE-283-010
18.0 cm / 7"





Joseph
WFE-284-001
15.0 cm / 6"



Cottle
WFE-284-002
16.0 cm / 6 1/4"



WFE-284-003 WFE-284-004 WFE-284-005
15.0 cm / 6"



Lange
WFE-284-006
22.0 cm / 8 1/2"



Forman
WFE-284-007
17.0 cm / 6 3/4"



Aufrecht
WFE-284-008
19.0 cm / 7 1/2"



Kilner
WFE-284-009
10.0 cm / 4"



Converse
WFE-284-010
12.0 cm / 4 1/2"



Freer
WFE-284-011
15.0 cm / 6"



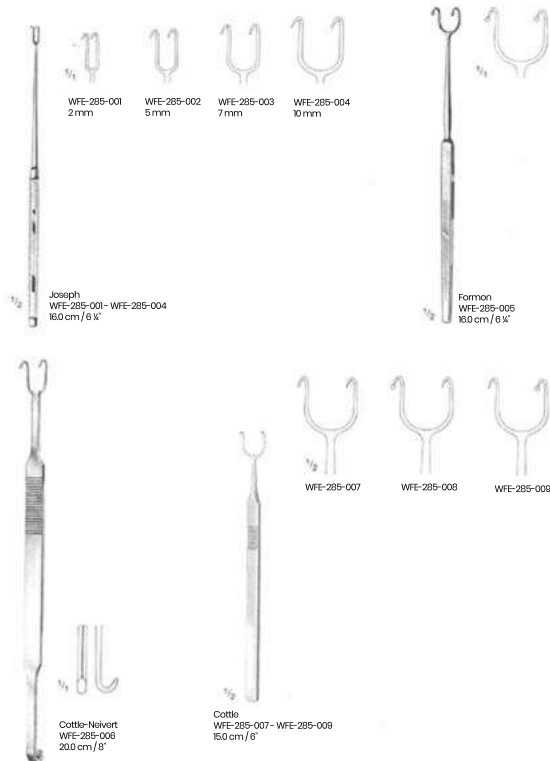



Cottle
WFE-286-001
14.0 cm / 5 1/2"



Noivert
WFE-286-002
16.0 cm / 6 1/4"



Cottle
WFE-286-003
15.0 cm / 6"



Cottle
WFE-286-004
15.0 cm / 6"



Aufrecht
WFE-286-005
13.5 cm / 5 1/4"



Yankauer (Septum Suture Needles)
WFE-286-006 - WFE-286-014

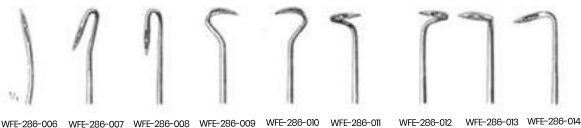

WFE-286-006 WFE-286-007 WFE-286-008 WFE-286-009 WFE-286-010 WFE-286-011 WFE-286-012 WFE-286-013 WFE-286-014





WFE-287-002



WFE-287-003



WFE-287-004



WFE-287-005



Krasner
WFE-287-001
20.0 cm / 8"



Cottle-Walsham
WFE-287-002-WFE-287-004
23.0 cm / 9"



Asch
WFE-287-005
23.0 cm / 9"





Prapp
WFE-288-001
210 cm / 8 1/4"



Foulikner
WFE-288-002
210 cm / 8 1/4"



Cockley
WFE-288-003 - WFE-288-008
170 cm / 6 3/4"



WFE-288-003



WFE-288-004



WFE-288-005



WFE-288-006



WFE-288-007



WFE-288-008



WFE-288-009





Beckman
WFE-289-001 - WFE-289-006
22.0 cm / 8 3/4"



Beckman
WFE-289-007 - WFE-289-012
22.0 cm / 8 3/4"



WFE-289-001
WFE-289-007



WFE-289-002
WFE-289-008



WFE-289-003
WFE-289-009



WFE-289-004
WFE-289-010



WFE-289-005
WFE-289-011



WFE-289-006
WFE-289-012





Beckmann
Wf-290-013 - Wf-290-017
22.0 cm / 8 5/8"



Wf-290-013



Wf-290-014



Wf-290-015



Wf-290-016



Wf-290-017



St. Clair-Thomson
Wf-290-018 - Wf-290-021
21.0 cm / 8 1/4"



Wf-290-018



Wf-290-019



Wf-290-020



Wf-290-021



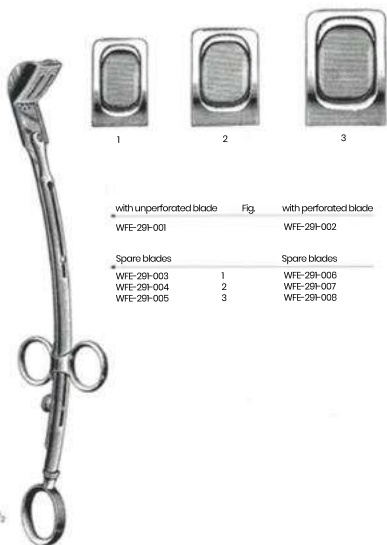

with unperforated blade	Fig.	with perforated blade
WFE-291-001		WFE-291-002
Spare blades		Spare blades
WFE-291-003	1	WFE-291-006
WFE-291-004	2	WFE-291-007
WFE-291-005	3	WFE-291-008

La Force
WFE-291-001-WFE-291-002 (with one blade)
25.0 cm / 10"

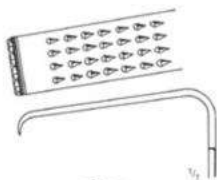

Bruenings-Brunk
WFE-291-009 (Antrum Retractors)
21.5 cm / 8 1/2"





Cardiovascular
Rib Shears, Sternum
Scissors, Sternum Chisel



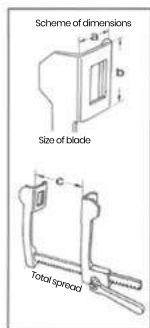

Cooley
for newborns

	a	b	c
WFE-294-001	12 mm	17 mm	75 mm



Cooley
pediatric size

	a	b	c
WFE-294-002	16 mm	30 mm	105 mm
WFE-294-003	21 mm	44 mm	150 mm



Cooley
for adults

	a	b	c
WFE-294-004	37 mm	49 mm	200 mm

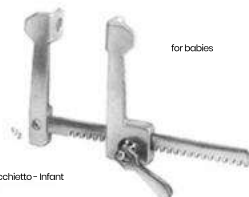
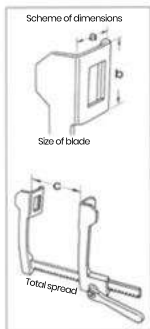

	a	b	c
WFE-295-005	15 mm	15 mm	75 mm



	a	b	c
WFE-295-008	31 mm	31 mm	100 mm



	a	b	c
WFE-295-007	38 mm	44 mm	135 mm
WFE-295-008	52 mm	62 mm	175 mm
WFE-295-009	85 mm	65 mm	175 mm





Schema of dimensions



Size of blade

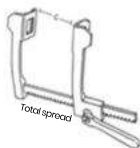

Total spread



Finocchetto - Baby

	a	b	c
WFE-296-010	18 mm	20 mm	75 mm



Finocchetto

	a	b	c	
WFE-296-011	40 mm	40 mm	185 mm	Small
WFE-296-012	45 mm	65 mm	200 mm	Medium
WFE-296-013	70 mm	65 mm	250 mm	Large





Lovelace
WFE-297-001
20.0 cm / 8"



Lovelace
WFE-297-002
20.0 cm / 8"





Code
WFE-298-001
18.5 cm / 7 1/4"

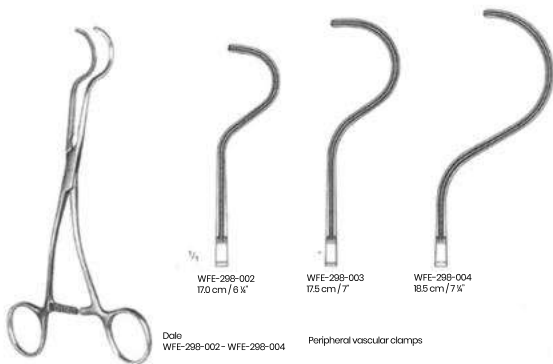

Code
WFE-298-002
17.0 cm / 6 3/4"

Code
WFE-298-003
17.5 cm / 7"

Code
WFE-298-004
18.5 cm / 7 1/4"

Code
WFE-298-002 - WFE-298-004

Peripheral vascular clamps



Cardiovascular Atrauma Tissue Forceps



27 mm



De Bakley
WFE-299-001 - 16.0 cm / 6 1/4"
WFE-299-002 - 20.0 cm / 8"
WFE-299-003 - 24.0 cm / 9 1/2"
WFE-299-004 - 30.0 cm / 12"

15 mm



De Bakley
WFE-299-005 - 16.0 cm / 6 1/4"
WFE-299-006 - 20.0 cm / 8"
WFE-299-007 - 24.0 cm / 9 1/2"

20 mm



De Bakley
WFE-299-008 - 16.0 cm / 6 1/4"
WFE-299-009 - 20.0 cm / 8"
WFE-299-010 - 24.0 cm / 9 1/2"
WFE-299-011 - 30.0 cm / 12"

20 mm

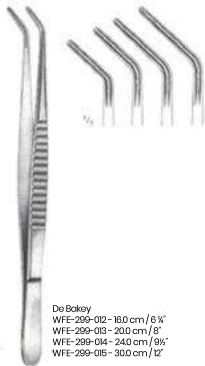

De Bakley
WFE-299-012 - 16.0 cm / 6 1/4"
WFE-299-013 - 20.0 cm / 8"
WFE-299-014 - 24.0 cm / 9 1/2"
WFE-299-015 - 30.0 cm / 12"

35 mm



De Bakley
WFE-299-016 - 16.0 cm / 6 1/4"
WFE-299-017 - 20.0 cm / 8"
WFE-299-018 - 24.0 cm / 9 1/2"
WFE-299-019 - 30.0 cm / 12"

20 mm



Coolley
WFE-299-020 - 16.0 cm / 6 1/4"
WFE-299-021 - 20.0 cm / 8"



WORTH FIELD
ENTERPRISES

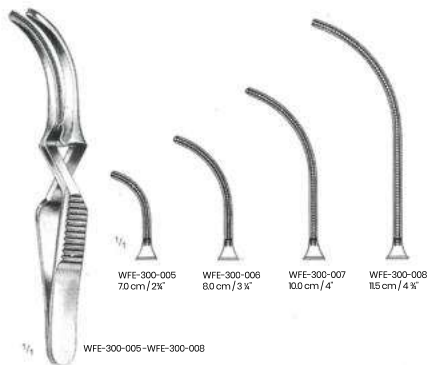
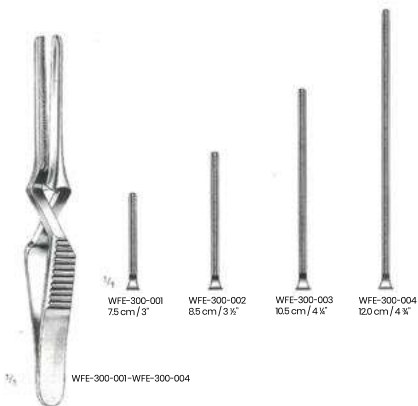

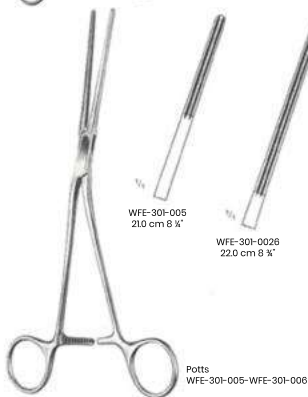
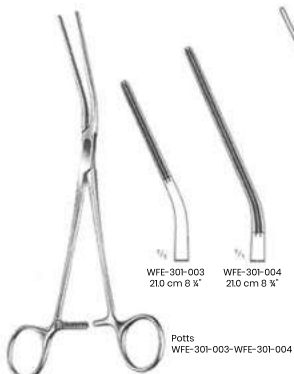
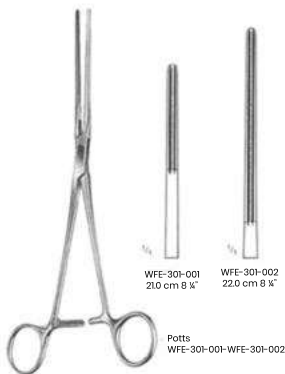

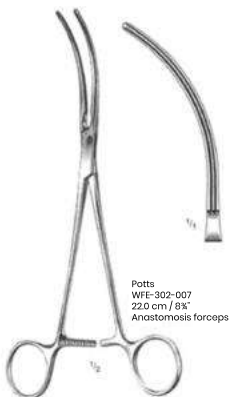

Potts
WFE-302-007
22.0 cm / 8 $\frac{3}{4}$ "
Anastomosis forceps

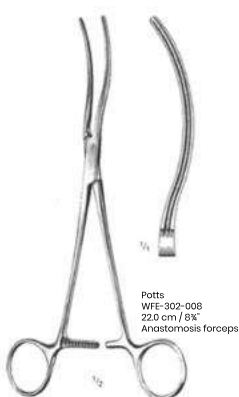

Potts
WFE-302-008
22.0 cm / 8 $\frac{3}{4}$ "
Anastomosis forceps



WFE-302-009
19.0 cm / 7 $\frac{1}{2}$ "

Da Bakery
WFE-302-009-WFE-302-010



WFE-302-010
23.0 cm / 9"





De Bakery
WFE-303-011
16.0 cm / 6 1/4"



De Bakery
WFE-303-012-WFE-303-013

WFE-303-012
19.0 cm / 7 1/2"

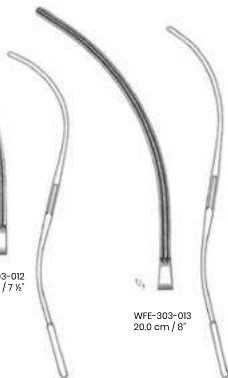

WFE-303-013
20.0 cm / 8"



Leland-jones
WFE-303-014-WFE-303-016

WFE-303-014
18.0 cm / 7"



WFE-303-015
19.0 cm / 7 1/2"



WFE-303-016
20.0 cm / 8"

Peripheral vascular clamps





Bainbridge
WFE-304-017-WFE-304-018

WFE-304-017
15.0 cm / 6"



WFE-304-018
18.0 cm / 7"



Bainbridge
WFE-304-019-WFE-304-020

WFE-304-019
15.0 cm / 6"



WFE-304-020
18.0 cm / 7"



De Bakay
WFE-304-021
20.0 cm / 8"

Rental artery clamp



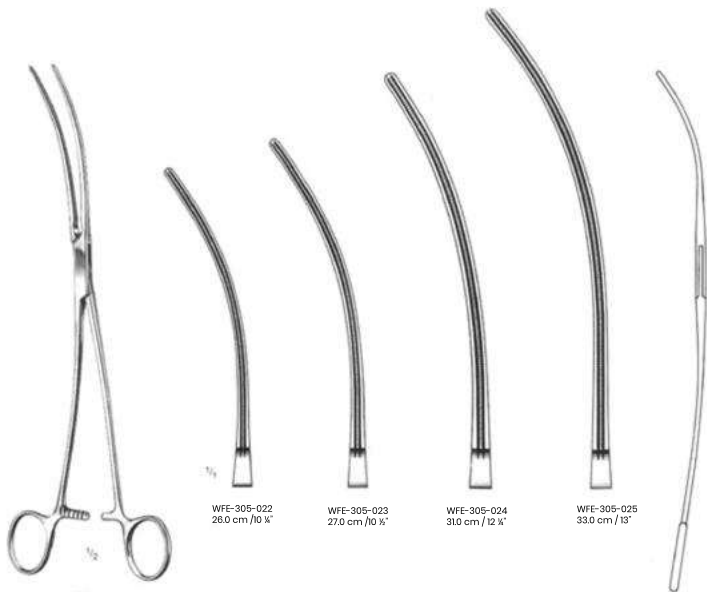

WFE-305-022-WFE-305-025
Aortic aneurysm clamps

WFE-305-022
26.0 cm / 10 1/4"

WFE-305-023
27.0 cm / 10 1/2"

WFE-305-024
31.0 cm / 12 1/4"

WFE-305-025
33.0 cm / 13"





De Bakay
WFE-306-001
28.0 cm / 11\"/>

De Bakay
WFE-306-002
30.0 cm / 11¾\"/>

Artic aneurysm clamps



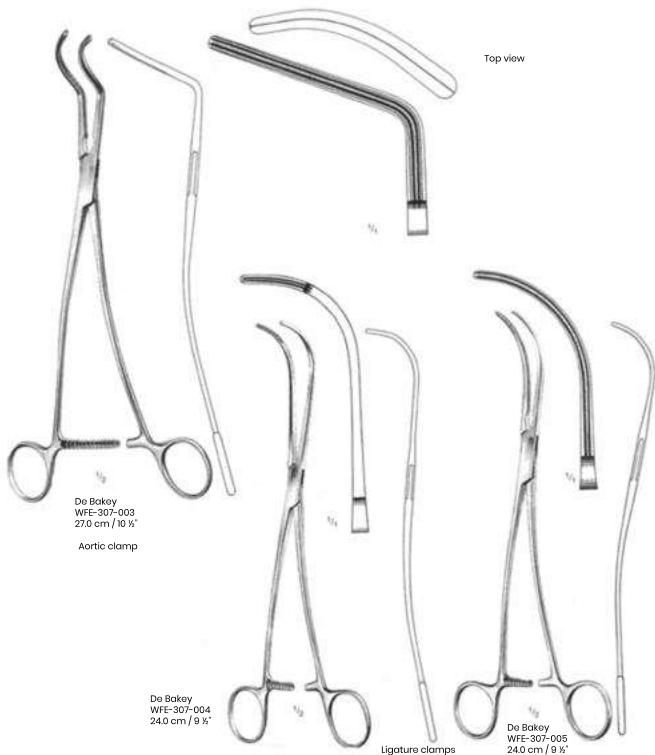

Top view

De Bakay
WFE-307-003
27.0 cm / 10 5/8"

Aortic clamp

De Bakay
WFE-307-004
24.0 cm / 9 1/2"

Ligature clamps

De Bakay
WFE-307-005
24.0 cm / 9 1/2"





De Bakay
WFE-308-006
26.0 cm, 10 1/4"

Aortic clamp



De Bakay
WFE-308-007
25.0 cm, 10"

Ligature Forceps



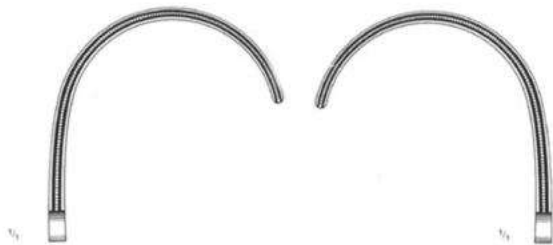

Weber
WFE-309-008
28.0 cm / 10 7/8"

left



Weber
WFE-309-009
28.0 cm / 10 7/8"

right

Aortic clamps



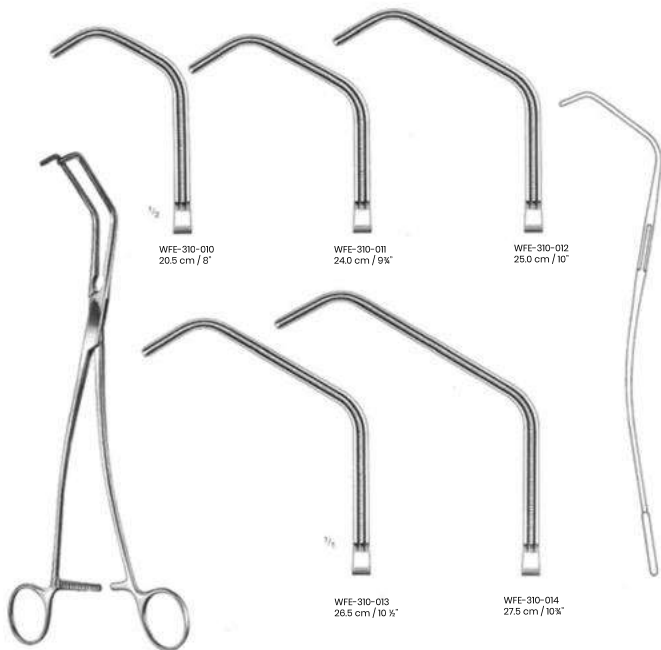

WFE-310-010
20.5 cm / 8"

WFE-310-011
24.0 cm / 9 1/2"

WFE-310-012
25.0 cm / 10"

WFE-310-013
26.5 cm / 10 1/2"

WFE-310-014
27.5 cm / 10 3/4"

Satinsky
WFE-310-010-WFE-310-014

Tangential occlusion clamps





Harken
WFE-311-015 - WFE-311-018



WFE-311-015
24.0 cm / 9 1/2"
Auricle clamps



WFE-311-018
24.0 cm / 9 1/2"



WFE-311-017
24.0 cm / 9 1/2"



WFE-311-018
24.0 cm / 9 1/2"



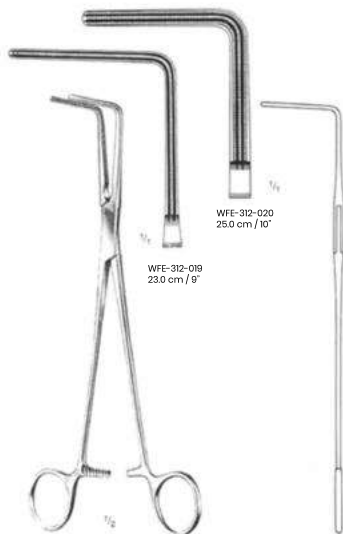

Lees
WFE-312-019-WFE-312-020

WFE-312-020
25.0 cm / 10"

WFE-312-019
23.0 cm / 9"

Bronchus clamps

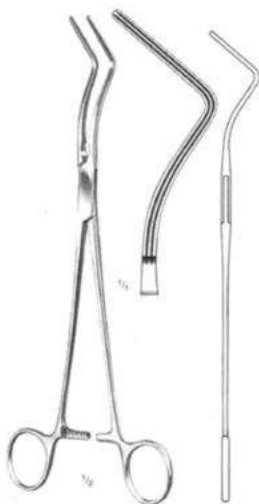

Lees
WFE-312-021
25.0 cm / 10"





Lambert-Kay
WFE-313-022-WFE-313-023



WFE-313-022



WFE-313-023

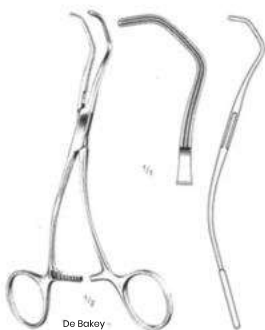

De Bakay
WFE-313-024
17.0 cm 6 3/4"



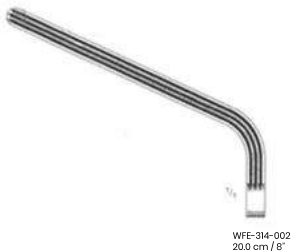

Morris-De Bakay
WFE-314-001-WFE-314-004

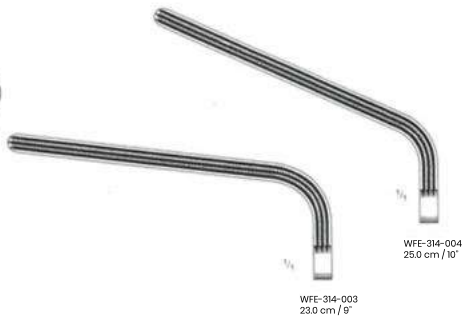

Aortic clamps





De Bakay-Bahnson
WFE-315-005-WFE-315-007



WFE-315-005
23.0 cm / 9"



WFE-315-006
24.0 cm / 9 1/2"



WFE-315-007
25.0 cm / 10"





WFE-316-008-WFE-316-011



WFE-316-008
21.5 cm / 8 1/2"



WFE-316-009
23.0 cm / 9"



WFE-316-010
27.0 cm / 10 1/2"



WFE-316-011
31.5 cm / 12 1/2"



WFE-316-012-WFE-316-015



WFE-316-012
21.5 cm / 8 1/2"



WFE-316-013
23.0 cm / 9"



WFE-316-014
27.0 cm / 10 1/2"



WFE-316-015
31.5 cm / 12 1/2"

COARCTATION CLAMPS





De Bokey
WFE-317-016-WFE-317-019

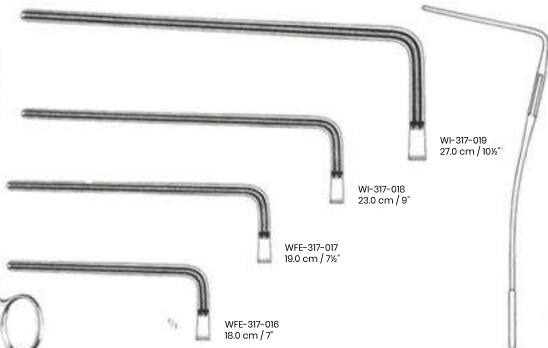

WFE-317-016
18.0 cm / 7"

WFE-317-017
19.0 cm / 7½"

WFE-317-018
23.0 cm / 9"

WI-317-019
27.0 cm / 10½"



Multi purpose clamps
WFE-317-020-WFE-317-023

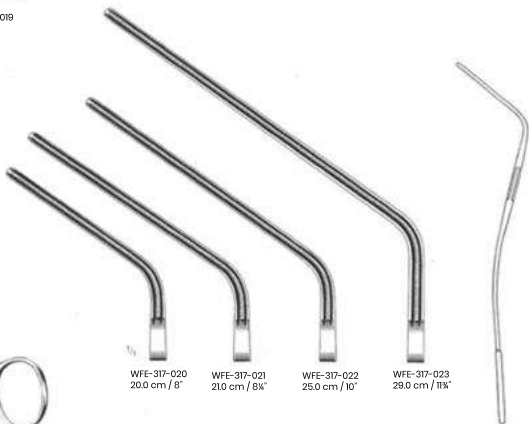

WFE-317-020
20.0 cm / 8"

WFE-317-021
21.0 cm / 8¼"

WFE-317-022
25.0 cm / 10"

WFE-317-023
29.0 cm / 11¼"





De Bakay-Pean
WFE-318-001-WFE-318-005



De Bakay-Mosquito
WFE-318-001
12.0 cm / 4"



WFE-318-002
14.0 cm / 5 1/2"



WFE-318-003
16.0 cm / 6 1/4"



WFE-318-004
18.0 cm / 7"



WFE-318-005
20.0 cm / 8"



De Bakay-Pean
WFE-318-006-WFE-318-010



De Bakay-Mosquito
WFE-318-006
12.0 cm / 4"



WFE-318-007
14.0 cm / 5 1/2"



WFE-318-008
16.0 cm / 6 1/4"



WFE-318-009
18.0 cm / 7"



WFE-318-010
20.0 cm / 8"



De Bakoy
WFE-319-001
17.0 cm / 6 3/4"

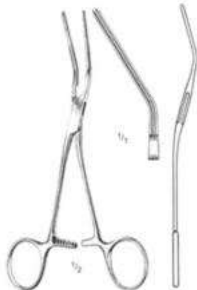

De Bakoy
WFE-319-002
16.0 cm / 6 1/4"

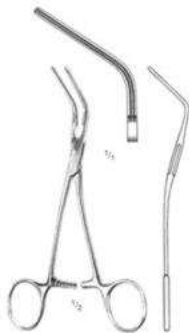

De Bakoy
WFE-319-003
15.0 cm / 6"



De Bakoy
WFE-319-004
15.0 cm / 6"



De Bakoy
WFE-319-005
17.0 cm / 6 3/4"



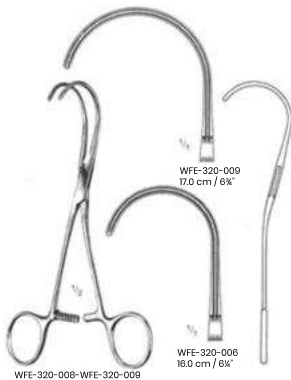



De Bakay
WFE-321-014
10.0 cm / 4"



De Bakay
WFE-321-015
11.0 cm / 4 1/4"



De Bakay
WFE-321-016
12.0 cm / 4 3/4"



De Bakay
WFE-321-017
12.0 cm / 4 3/4"

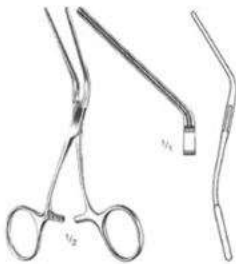

De Bakay
WFE-321-018
13.0 cm / 5 1/4"





Cooley
WFE-322-001-WFE-322-002
14.0 cm / 5 1/2"



WFE-322-001
14.0 cm / 5 1/2"

WFE-322-002
14.0 cm / 5 1/2"



Cooley
WFE-322-003
14.0 cm / 5 1/2"



Cooley
WFE-322-004
14.0 cm / 5 1/2"



Cooley
WFE-322-005
14.0 cm / 5 1/2"



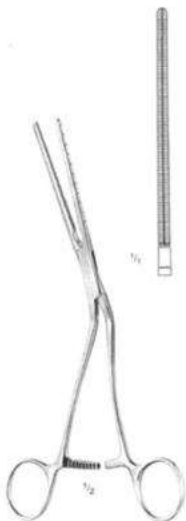

Cooley
WFE-323-001
21.0 cm / 8 1/4"

Iliac clamp



Cooley
WFE-323-002
17.0 cm / 6 3/4"

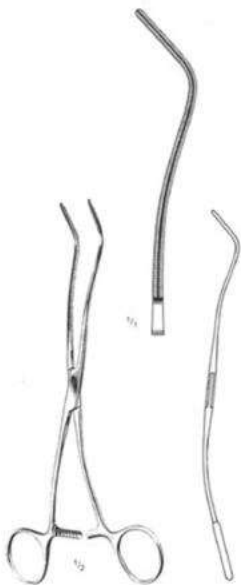

Cooley
WFE-323-003
20.0 cm / 8"



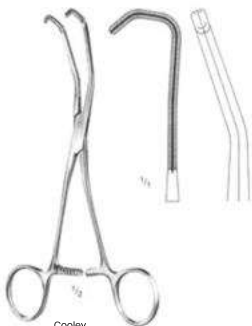

Cooley
WFE-324-004
17.0 cm / 6 3/4"



Cooley
WFE-324-005
16.0 cm / 6 1/4"



Cooley
WFE-324-006
15.0 cm / 6"



Cooley
WFE-324-007
15.5 cm / 6 1/8"



Cooley
WFE-324-008
17.0 cm / 6 3/4"





Coolley
WFE-325-009
17.0 cm / 6 3/4"



Coolley
WFE-325-010
17.0 cm / 6 3/4"



Coolley
WFE-325-011
17.0 cm / 6 3/4"
Coarctatin Clamps

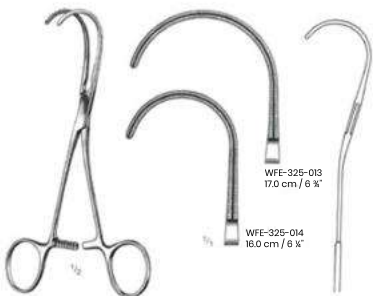

Coolley
WFE-325-012-WFE-325-013
Ligature Clamps

WFE-325-013
17.0 cm / 6 3/4"

WFE-325-014
16.0 cm / 6 1/4"



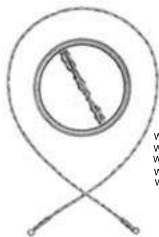

Olivecrona
WFE-326-001-WFE-326-005

WFE-326-001- 30.0 cm / 12"
WFE-326-002- 40.0 cm / 16"
WFE-326-003- 50.0 cm / 20"
WFE-326-004- 60.0 cm / 24"
WFE-326-005 - 70.0 cm / 28"



WFE-326-006



Martel
WFE-326-007
33.0 CM / 13"





Allis-Baby
WFE-327-001
12.0 cm / 4 3/4"
4 x 5 teeth

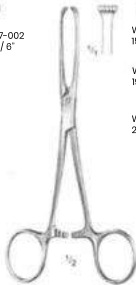

Allis Tissue
WFE-327-002-WFE-327-005

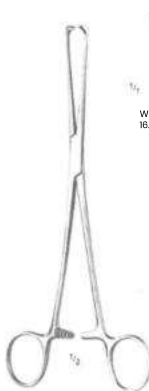

WFE-327-006
18.0 cm / 6 3/4"



WFE-327-007
20.0 cm / 8"



WFE-327-008
25.0 cm / 10"



WFE-327-009
30.0 cm / 12"

Allis-Atrauma
WI-327-006-WI-327-009



Intestines Stomach Rectum Tissue and Organ Holding Forceps



Allis-Adair
WFE-328-010
15.0 cm / 6"
10 x II teeth



Boys-Allis
WFE-328-011
15.0 cm / 6"

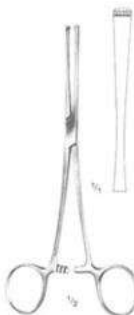

Lockwood-Allis
WFE-328-012- 16.0 cm / 6 1/4"
WFE-328-013-20.0 cm / 8"



Judic-Allis
WFE-328-014- 15.0 cm / 6"
WFE-328-015-19.0 cm / 6 3/4"



Thomas-Allis
WFE-328-016
20.0 cm / 8"

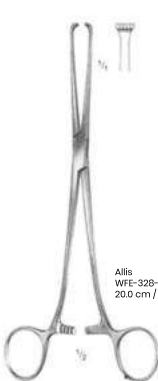

Allis
WFE-328-017
20.0 cm / 8"

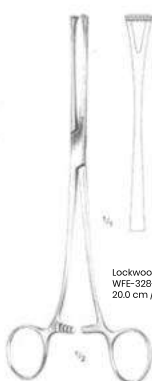

Lockwood
WFE-328-018
20.0 cm / 8"



Williams
WFE-328-019
16.0 cm / 6 1/4"



Intestines Stomach Rectum Tissue and Organ Holding Forceps



Babcock
WFE-329-020-WFE-329-023



WFE-329-020
16.0 cm / 6 1/4"

WFE-329-021
18.0 cm / 7"

WFE-329-022
20.0 cm / 8"

WFE-329-023
24.0 cm / 9 1/2"

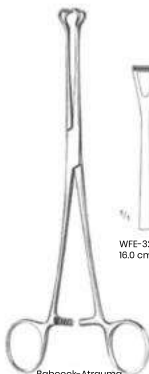

Babcock-Atrauma
WFE-329-024-WFE-329-025

WFE-329-024
16.0 cm / 6 1/4"

WFE-329-025
20.0 cm / 8"

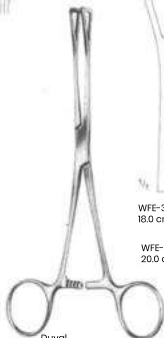

Duval
WFE-329-026-WFE-329-029

WFE-329-026
18.0 cm / 7"

WFE-329-027
20.0 cm / 8"

WFE-329-028
20.0 cm / 7"

WFE-329-029
23.0 cm / 9"

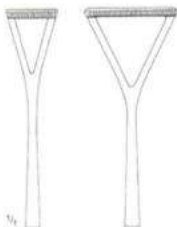



Brunner
WFE-330-01
24.0 cm / 9 $\frac{1}{2}$ "



WFE-330-002
21.0 cm / 8 $\frac{1}{4}$ "

WFE-330-003
23.0 cm / 9"



WFE-330-004
21.0 cm / 8 $\frac{1}{4}$ "

WFE-330-005
23.0 cm / 9"

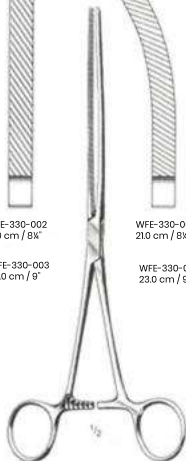

Dyen
WFE-330-002-WFE-330-005



WFE-330-006
18.0 cm / 7"



WFE-330-007
18.0 cm / 7"

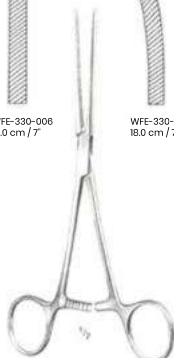

Dyen-baby
WFE-330-006-WFE-330-007
18.0 cm / 7"





WFE-331-008
21.0 cm / 8 1/4"

WFE-331-009
23.0 cm / 9"



Mayo-Robson
WFE-331-008-WFE-331-011

WFE-331-010
21.0 cm / 8 1/4"

WFE-331-011
23.0 cm / 9"

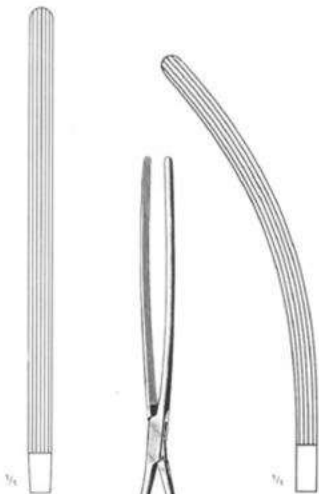

WFE-331-012

WFE-331-013



Mayo-Robson
WFE-331-012-WFE-331-013
25.0 cm / 10"



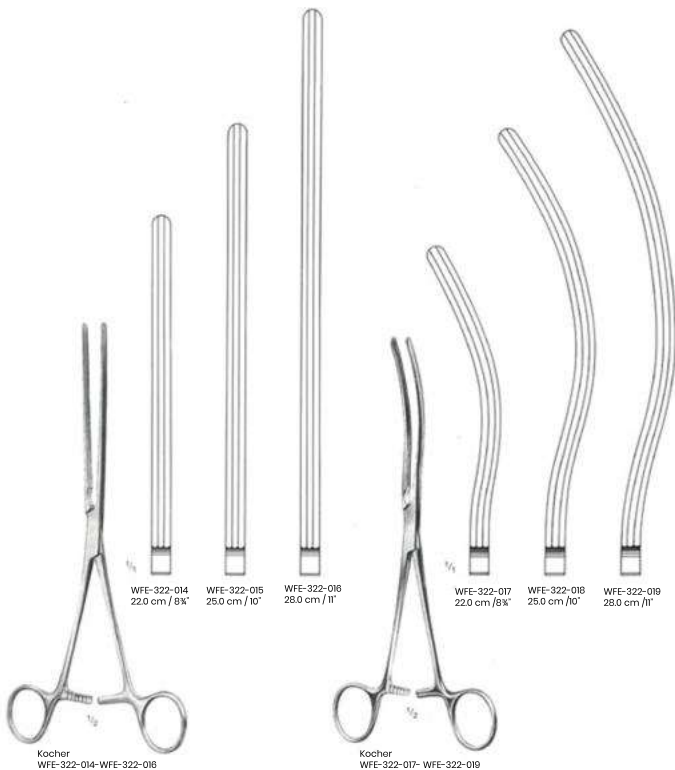

Intestines Stomach Rectum Intestinal and Stomach Clamps (Crushing Clamps)

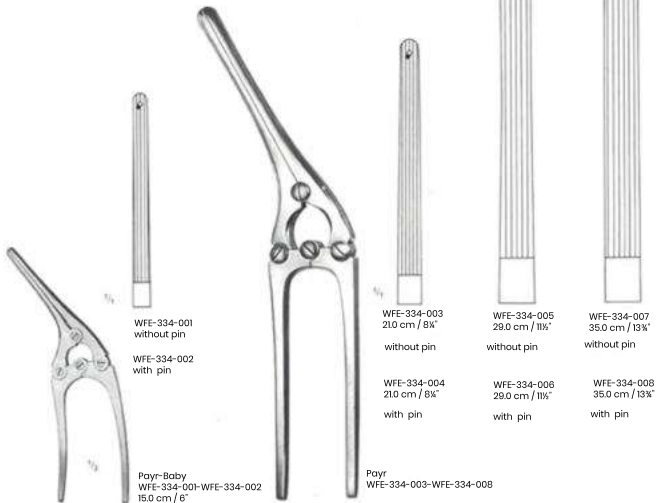

Intestines Stomach Rectum Antrauma Intestinal and Stomach Clamps Forceps



Doyen- Atrauma
WFE-335-001-WFE-335-004



WFE-335-001
16.0 cm / 6 1/4"



WFE-335-002
18.0 cm / 7"



WFE-335-003
21.0 cm / 8 1/4"



WFE-335-004
23.0 cm / 9"



Doyen- Atrauma
WFE-335-005-WFE-335-008



WFE-335-005
16.0 cm / 6 1/4"



WFE-335-006
18.0 cm / 7"



WFE-335-007
21.0 cm / 8 1/4"



WFE-335-008
23.0 cm / 9"





Czorny
WFE-336-001
22.0 cm / 8 1/4"

Sims
WFE-336-002
15.0 cm / 6"

Sims
WFE-336-003
15.0 cm / 6"

Sims
WFE-336-004
15.0 cm / 6"

*with interchangeable fiber optic light carrier



Intestines Stomach Rectum Rectal Specula, Anal Retractors, Anoscope Proctoscope



Ives-Fenster
WFE-337-001
22 mm Ø



Ives-Fenster
WFE-337-002
22 mm Ø



Hirschmann
WFE-337-003-16 mm Ø x 65 mm
WFE-337-004-16 mm Ø x 65 mm
WFE-337-005-22 mm Ø x 65 mm



Kelly
WFE-337-006-21 mm Ø x 50 mm
WFE-337-007-27 mm Ø x 50 mm



Kelly
WFE-337-008-22 mm Ø x 50 mm
WFE-337-009-22 mm Ø x 100 mm
WFE-337-010-22 mm Ø x 140 mm



Newman
WFE-337-011-16 mm Ø x 63 mm
WFE-337-012-16 mm Ø x 63 mm
WFE-337-013-23 mm Ø x 63 mm



Intestines Stomach Rectum Rectal Biopsy Specimen Forceps

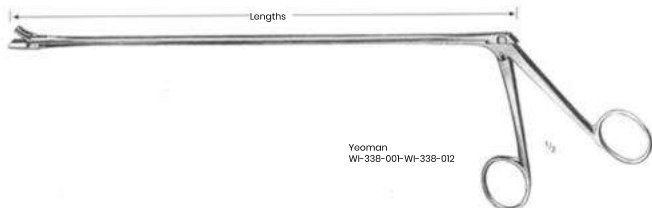

Yeoman
WI-338-001-WI-338-012



WFE-338-001-28.0 cm / 11"
WFE-338-002-35.0 cm / 13 3/4"
WFE-338-003-42.0 cm / 16 1/2"



WFE-338-004-28.0 cm / 11"
WFE-338-005-35.0 cm / 13 3/4"
WFE-338-006-42.0 cm / 16 1/2"



WFE-338-007-28.0 cm / 11"
WFE-338-008-35.0 cm / 13 3/4"
WFE-338-009-42.0 cm / 16 1/2"



WFE-338-010-28.0 cm / 11"
WFE-338-011-35.0 cm / 13 3/4"
WFE-338-012-42.0 cm / 16 1/2"

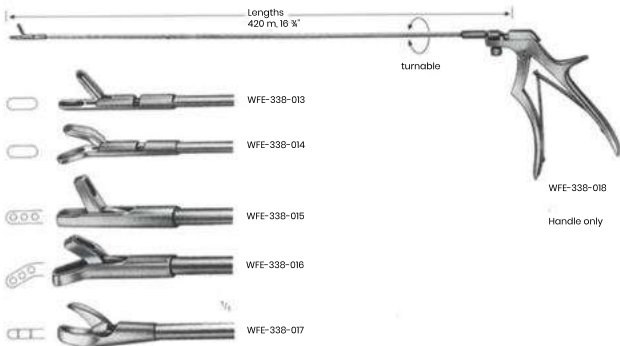

turnable

WFE-338-018

Handle only

WFE-338-013

WFE-338-014

WFE-338-015

WFE-338-016

WFE-338-017



*Intestines Stomach
Rectal Biopsy Specimen Forceps,
Haemorrhoidal (Pile)
Forceps*

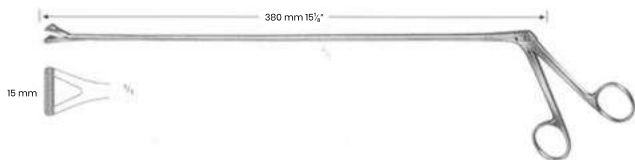

WFE-339-001

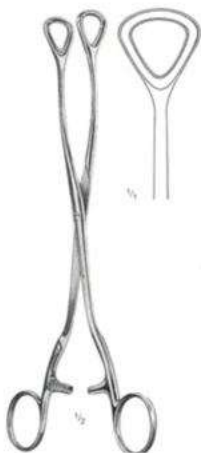

Lucer
WFE-339-002
24.5 cm / 9 3/4"

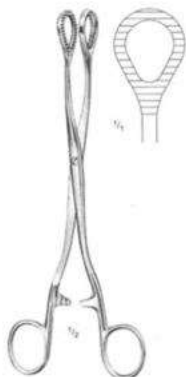

Heywood-Smith
WFE-339-003
20.0 cm / 8"

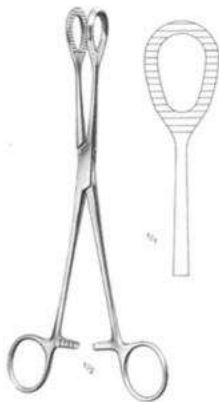

Heywood-Smith
WFE-339-004
21.0 cm / 8 1/4"



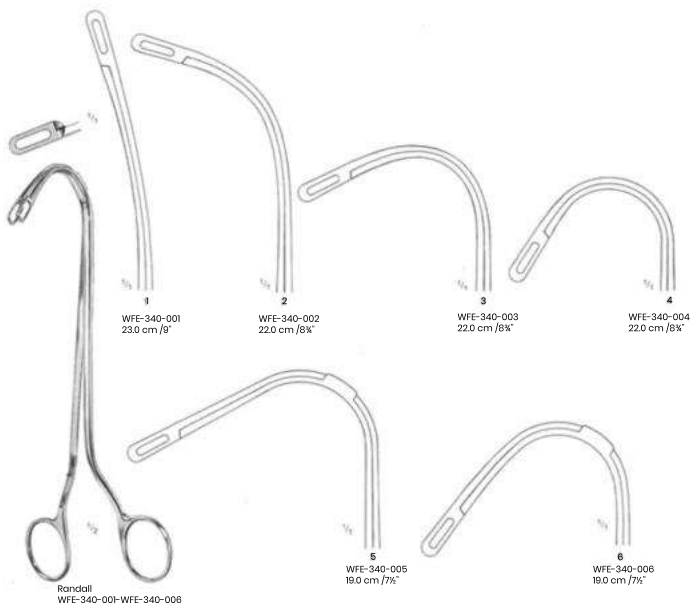

Liver, Gall, Bladder, Kidney Gall Stone Probes, Gall Duct Dilators

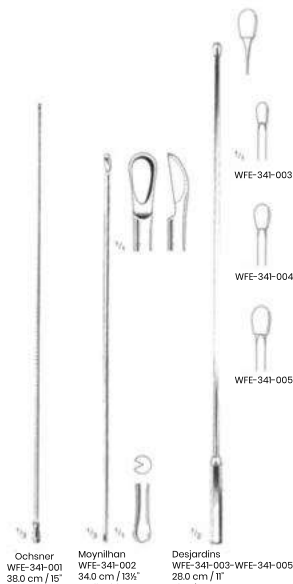
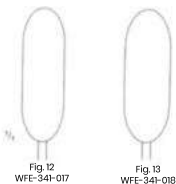
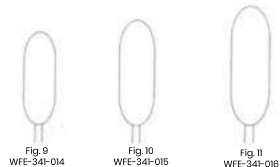
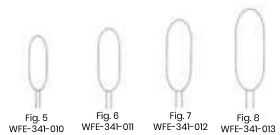



Mayo-Blake
WFE-342-001
20.0 cm / 8"



Mayo-Blake
WFE-342-002
20.0 cm / 8"

WFE-342-008
26.5 cm / 10 1/2"
maleable

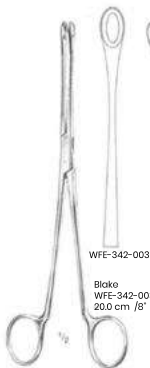

Blake
WFE-342-003-WFE-342-004
20.0 cm / 8"



Mixer
WFE-342-005
22.0 cm / 8 3/4"



Desjardins
WFE-342-006-WI-342-007
23.0 cm / 9"



Liver, Gall, Bladder, Kidney Gall Stone Scoops

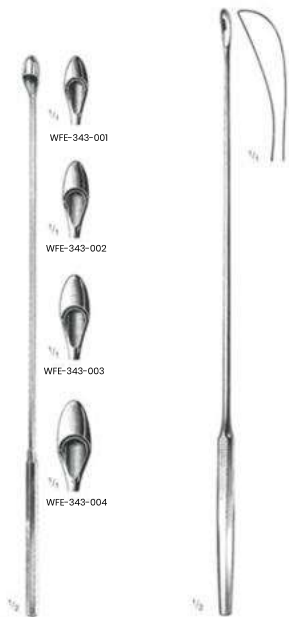

WFE-343-001

WFE-343-002

WFE-343-003

WFE-343-004

Desjardins
WFE-343-001-WFE-343-004
30.0 cm / 12"

Luer-Koerte
WFE-343-005-WFE-343-012
32.0 cm / 12 1/4"
malleable

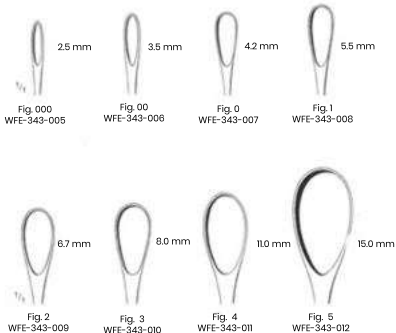



Moore
WFE-344-013
28.0 cm / 11"



Mayo
WFE-344-014
28.0 cm / 11"



WFE-344-015
34.0 cm / 1 2/8"



Fergusson
WFE-344-016-WI-344-018



WFE-344-016
21.0 cm / 8 1/4"



WFE-344-017
22.0 cm / 8 5/8"



WFE-344-018
23.5 cm / 9 1/4"





Young
WFE-345-001
21.0 cm / 8 1/4"

Young
WFE-345-002
22.0 cm / 8 3/4"

Young
WFE-345-003
21.0 cm / 8"

Young
WFE-345-004
22.0 cm / 8 3/4"



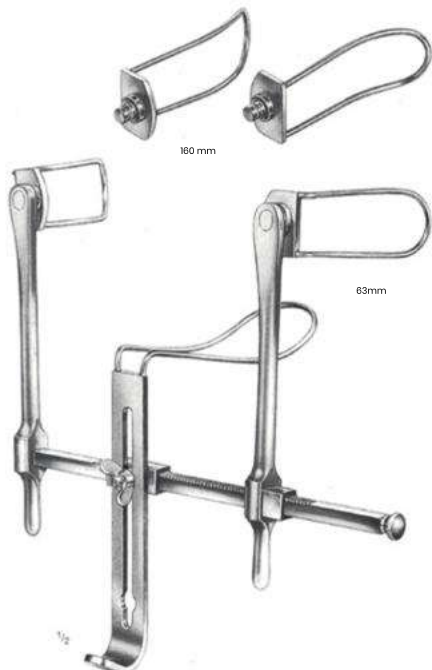

Gosset
WFE-346-001
Bladder Retractor



Millin
WFE-346-002
Bladder Neck Retractor



Bladder, Urology Dilating Bougies, Metal Catheters

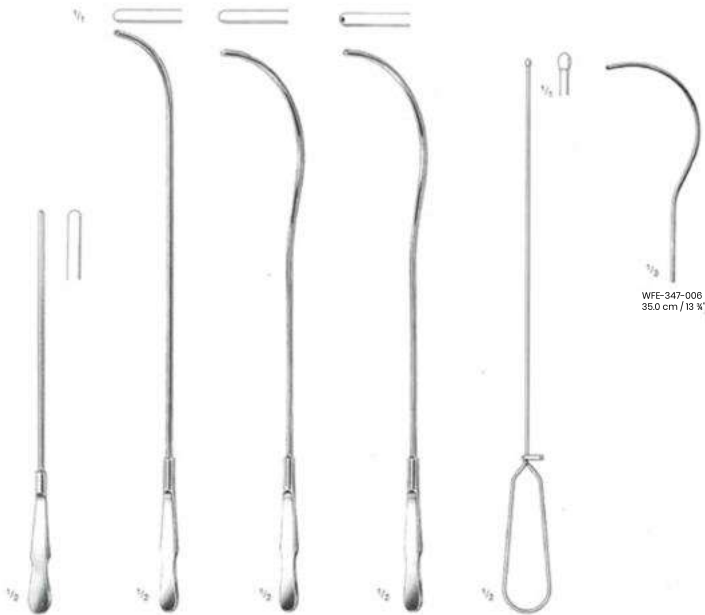

WFE-347-006
35.0 cm / 13 3/4"

Dittan
WFE-347-002
No. 8-30(French)

Van Buren
WFE-347-002
No. 8-36(French)

Guyon
WFE-347-003
No. 10-30(French)

Guyon
WFE-347-004
No. 10-30(French)

Catheter
WFE-347-005
39.0 cmm / 15 1/2"
straight





Fenster Operating Speculum
WFE-348-001
slotted tube . 2 3/4" long x 1 1/8"
diameter (6cm x 3.2cm)



Smith Anal Retractor
WFE-348-002
maximum opening 10.2 cm / 4"
swivel blades 2 3/8" deep x 7/8"
wide (7 cm x 2.2cm)



Barr Anal Retractor
WFE-348-003
20.0 cm / 8", soft - retaining.
Blades 2 1/4" deep x 7/8"
wide (7 cm x 2.2cm)



Prot Rectal Speculum
WFE-348-004
Blades 3 1/2" deep x 1" wide (8.9 cm x 2.5cm)
diameter at opening] 3/4" (4.4 cm)



Bodenhammer Rectal Speculum
WFE-348-005
Blades 3 1/2" deep x 3/4" wide (8.9 cm x 1.9cm)
diameter at opening] 7/8" (2.2 cm)



Sims Rectal Speculum
WFE-348-006
Blades 3 1/2" deep x 7/8" wide (8.9 cm x 2.2cm)
diameter at opening] 3/8" (1.6 cm), fenestrated



Rectal and Gento Urinary Specula



fanster (Ives) Rectal Speculum
 WI-349-007
 3¼" long x 1" diameter (8.3 cm x 2.5 cm)



Hirschman Anasopes
 WI-349-013
 Small - 2½" long x ⅝" diameter (6.4 cm x 1.4 cm)
 WI-349-014
 Medium - 2¾" long x ⅞" diameter (7 cm x 1.7 cm)
 WI-349-015
 Large - 3½" long x 7⁄8" diameter (8.9 cm x 2.2 cm)



Chelsea-Eaton Anal Specula
 WFE-349-008
 Small - 2½" long x 7⁄8" diameter (6.4 cm x 2.2cm),
 WFE-349-009
 Large - 2½" long x 1 ⅞" diameter (6.4cm x 3.1cm)



Brinkerhoff Rectal Specula
 WFE-349-016
 Small-2½" long x 1" diameter(8.9 cm x 2.5cm), tapering to ½" (1.3 cm)
 WFE-349-017
 Medium- 4" long x 1" diameter (10.2cm x 2.5 cm) tapering to ⅝" _ 1.6 cm)
 WFE-349-018
 Large - 4¾" long x ¾" diameter (12.1cm x 3.2 cm) tapering to ¾"(1.9 cm)

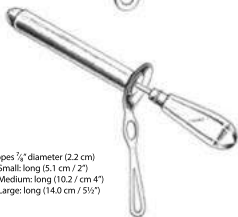

Kelly Proctoscopes 7⁄8" diameter (2.2 cm)
 WFE-349-010-Small: long (5.1 cm / 2")
 WFE-349-011-Medium: long (10.2 / cm 4")
 WFE-349-012-Large: long (14.0 cm / 5½")



Kelly Sphincteroscopes
 WFE-349-019-2" long x 1" diameter(5.1 x 2.5 cm)
 tapering to ⅞"(2.1 cm)



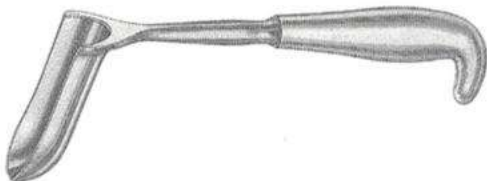

Hill-Ferguson Rectal Retractors

WFE-350-020-Small: $2\frac{1}{2}$ " x $\frac{1}{8}$ " wide (6.4 cm x 2.2cm) blade

WFE-350-021-Large: 3" x $\frac{3}{16}$ " wide (7.6 cm x 3cm) blade

WFE-350-022-Large: 3" x $\frac{1}{4}$ " wide (7.6 cm x 3.8cm) blade



Sawyer Rectal Retractors

WFE-350-023-Small: $2\frac{1}{2}$ " x $\frac{3}{16}$ " wide (6.4 cm x 2.2cm) blade

WFE-350-024-Medium: 3" x $\frac{1}{2}$ " wide (7.6 cm x 2.9cm) blade

WFE-350-025-Large: $3\frac{1}{2}$ " x $\frac{1}{2}$ " wide (8.9 cm x 3.8cm) blade



Tracheotomy Trachea Dilators and Trachea Tubes



Laborde
WFE-351-001
14.0 cm / 5 1/2"



Trousseau
WFE-351-002
14.0 cm / 5 1/2"



Bose
WFE-351-003
7.0 cm / 2 3/4"

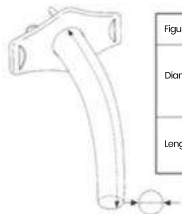

Jackson-Trachea Tubes
WFE-351-004 - WFE-351-013

International Scale

	WFE-351-004	WFE-351-005	WFE-351-006	WFE-351-007	WFE-351-008	WFE-351-009	WFE-351-010	WFE-351-011	WFE-351-012	WFE-351-013
Figure	0	1	2	3	4	5	6	7	8	9
Diameter	4	5	6	7	8	9	10	11	12	13mm
Length of outer tube	45	50	55	60	65	70	75	80	85	90mm

Length
from shield along outer
curvature to end of tube

Diameter (ø)
at the end of the outer tube
in millimeters





Ferguson
WFE-352-001 - 25 mm Ø
WFE-352-002 - 30 mm Ø
WFE-352-003 - 35 mm Ø

* Metal Specula, tubular shape



Collin
WFE-352-004
5 x 10 mm



Cusco
WFE-352-005 - 75 x 32 mm
WFE-352-006 - 85 x 35 mm
WFE-352-007 - 100 x 35 mm
Vaginal Specula with lateral
ratchet, with folding handles

WFE-352-008 - 85 x 35 mm
* with interchangeable fiber optic light carrier
* fiber optic light carrier



Cusco
WFE-352-009
75 x 17 mm
conical shape, virgin size





Cusco
WFE-353-010 - 80 x 22 mm
WFE-353-011 - 100 x 25 mm
WFE-353-012 - 105 x 27 mm



* Swiss pattern, narrow, with lateral ratchet, with holding handles

Cusco
WFE-353-013 - 75 x 32 mm
WFE-353-014 - 85 x 35 mm
WFE-353-015 - 100 x 37 mm



* with ratchet at the folding handles



Collin
WFE-353-016
65 x 20 mm



Collin
WFE-353-017 - 85 x 30 mm
WFE-353-018 - 100 x 35 mm
WFE-353-019 - 110 x 40 mm
WFE-353-020 - 100 x 35 mm

* detachable
* with interchangeable fiber optic light carrier



Collin-Landau
WFE-353-021
100 x 35 mm

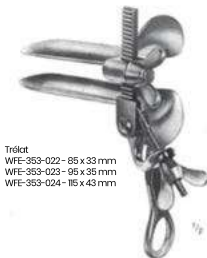

Trélat
WFE-353-022 - 85 x 33 mm
WFE-353-023 - 95 x 35 mm
WFE-353-024 - 115 x 43 mm

* detachable, with folding handles



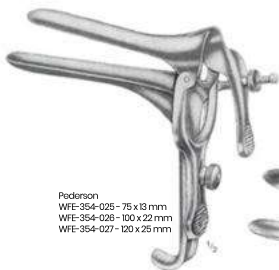

Pederson
WFE-354-025 - 75 x 13 mm
WFE-354-026 - 100 x 22 mm
WFE-354-027 - 120 x 25 mm



Graves
WFE-354-028 - 75 x 20 mm
WFE-354-029 - 95 x 35 mm
WFE-354-030 - 115 x 35 mm



Somm
WFE-354-031 - 100 x 17/20 mm
WFE-354-032 - 100 x 25/30 mm



Kristeller Specula

- Fig1 WFE-354-033 - 70 x 27 mm
Fig2 WFE-354-034 - 80 x 30 mm
Fig3 WFE-354-035 - 90 x 36 mm



Kristeller Retractors

- Fig1 WFE-354-036 - 75 x 23 mm
Fig2 WFE-354-037 - 85 x 26 mm
Fig3 WFE-354-038 - 100 x 32 mm



Kristeller
Set of 1 Spectulum
and 1 Retractor each
Fig1 WFE-354-039
Fig2 WFE-354-040
Fig3 WFE-354-041





Sims

WFE-355-042 - 65 x 25 mm
- 70 x 30 mm
WFE-355-043 - 70 x 30 mm
- 70 x 35 mm
WFE-355-044 - 85 x 35 mm
- 90 x 40 mm

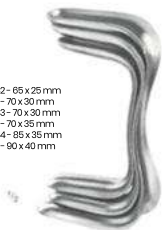

Jackson

WFE-355-045 - 75 x 35 mm
WFE-355-046 - 90 x 35 mm
WFE-355-047 - 100 x 35 mm
WFE-355-048 - 75 x 40 mm
WFE-355-049 - 90 x 40 mm
WFE-355-050 - 100 x 40 mm

with conically shaped blades, virgin size



Kristeller Specula
WFE-355-051 - 105 x 18 mm
WFE-355-052 - 105 x 21 mm



Kristeller Retractors
WFE-355-053 - 10 x 14 mm
WFE-35-054 - 110 x 17 mm



Kristeller
Set of I Spectulum and I Retractor
WFE-355-055
WFE-355-056



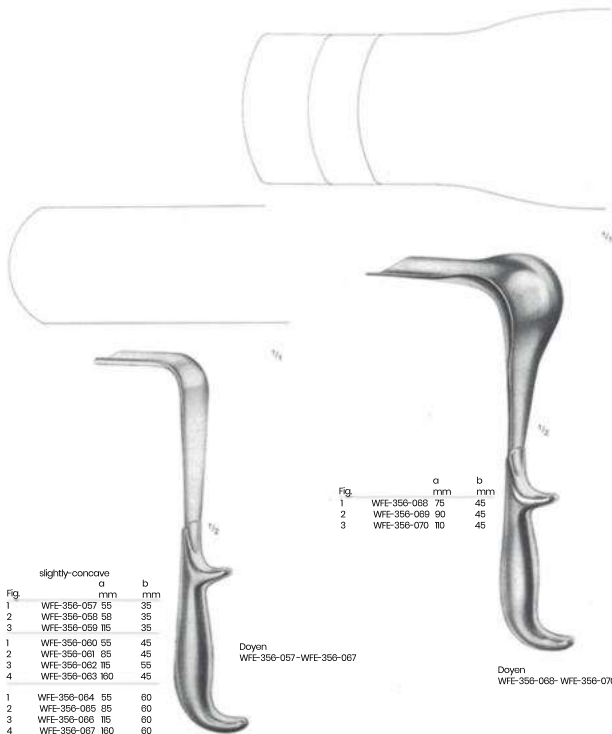

Fig.		slightly-concave	
		a mm	b mm
1	WFE-356-057	55	35
2	WFE-356-068	58	35
3	WFE-356-059	115	35
1	WFE-356-060	55	45
2	WFE-356-061	65	45
3	WFE-356-062	115	55
4	WFE-356-063	160	45
1	WFE-356-064	55	60
2	WFE-356-065	85	60
3	WFE-356-066	115	60
4	WFE-356-067	180	60

Fig.		a		b	
		mm		mm	
1	WFE-356-068	75	45	45	45
2	WFE-356-069	90	45	45	45
3	WFE-356-070	110	45	45	45

Doyen
WFE-356-057-WFE-356-067

Doyen
WFE-356-068- WFE-356-070





85 x 36 mm

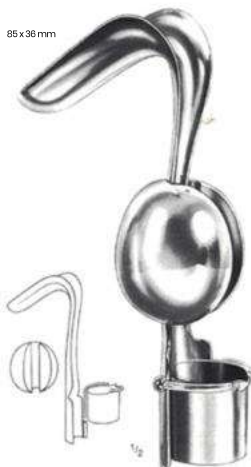

Samuel
WFE-357-071

* complete, with removable weight and metal strainer with perforated bottom for retaining specimen

Samuel
WFE-357-072

* Metal Strainer with perforated bottom only

80 x 38 mm



Auvard
WFE-357-073

* complete, with removable weight





70 x 30 mm



Doyen Vaginal Speculum
WFE-358-074
24.0 cm / 9 1/2"



O'Sullivan-O'Connaw
WFE-385-075

* Vaginal Speculum, for examination and operative work, self-retaining, with adjustable frame, Loktite ratchet, 2 mobile lateral blades and 3 interchangeable blades fig. 1- 3.

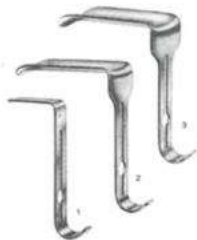

Fig. 1 = 45 x 17 mm
Fig. 2 = 90 x 37 mm
Fig. 3 = 90 x 45 mm





Friedman
WFE-359-076
10.0 cm / 4"

* Retractor, self-retaining, for perineorrhaphy



Kogan
WFE-359-077
24.0 cm / 9 1/2"

* without ratchet



Kogan
WFE-359-078
24.0 cm / 9 1/2"

* with scale-ratchet and fixing screws





Pieces per set	Set	
14	40 - 17.0	WFE-360-001
26	10 - 26.0	WFE-360-002





WFE-361-003-WFE-361-004

WFE-361-003
Set of 14 dilators
(4.0 - 17.0 mm Ø), in metal case with hinged lid

WFE-361-004
Set of 26 dilators
(1.0 - 26.0 mm Ø), in metal case with hinged lid



WFE-361-005
Set of 8 dilators
(3.0/4.0 - 17.0/18.0 mm Ø)

WFE-361-006
Set of 13 dilators
(1.0-2.0 - 25.0/26.0 mm Ø)





WFE-362-007

WFE-362-007
Set of 8 dilators
(3.0/4.0 - 17.0/18.0 mm Ø)
in boilable canvas roll



WFE-362-008

WFE-362-008
Set of 8 dilators
(3.0/4.0 - 17.0/18.0 mm Ø)
in metal case with hinged lid



WFE-362-009

WFE-362-009
Set of 13 dilators
(1.0/2.0 - 25.0/26.0 mm Ø)
in metal case with hinged lid



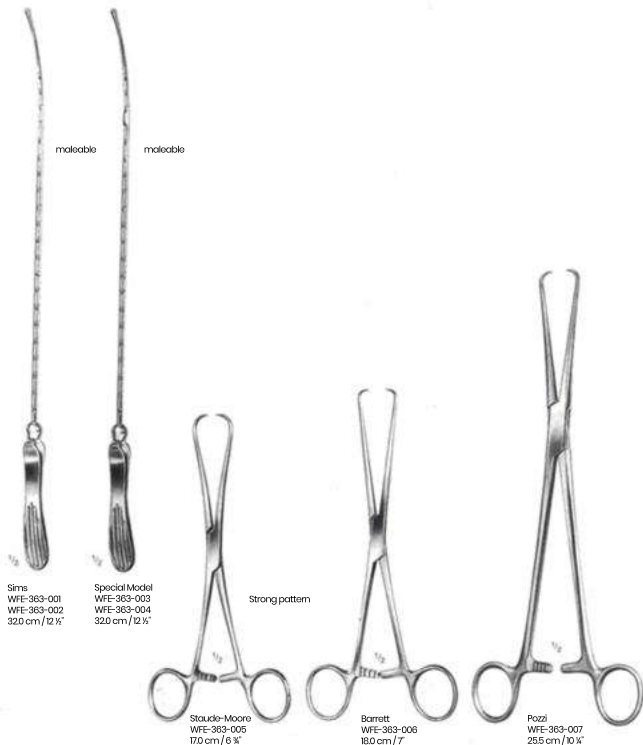



Schroeder
WFE-364-008
25.0 cm / 10"



Braun
WFE-364-009
25.0 cm / 10"



Duplay
WFE-364-010
28.0 cm / 11"





Amniotome for the amnion bladder



Becham
WFE-365-011
26.0 cm / 10 1/4"



Skene
WFE-365-012
24.0 cm / 9 1/2"



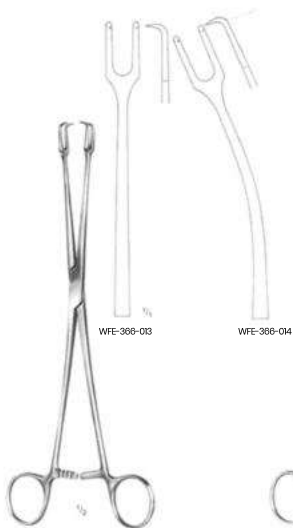

WFE-366-013

WFE-366-014

Schroeder
WFE-366-013-WFE-366-014
240 cm / 9 1/2"



Toole
WFE-366-015
230 cm / 9"

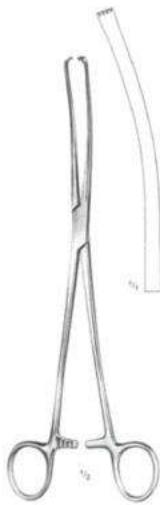

Iowa
WFE-366-016
260 cm / 10 1/4"

for the amnion bladder





MUSELUX
WFE-367-017-WFE-367-019
240 cm / 9 1/2"



6 mm

WFE-367-017



8 mm

WFE-367-018



10 mm

WFE-367-019



MUSELUX
WFE-367-020-WFE-367-021
240 cm / 9 1/2"

curved sideways



6 mm

WFE-367-020



8 mm

WFE-367-021



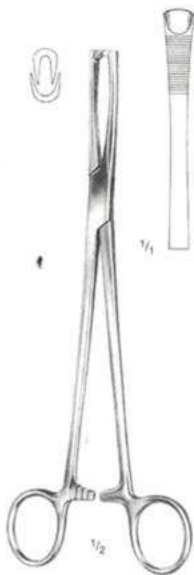

Jacobs
WFE-369-022
210 cm / 8 1/4"



Hanroin
WFE-369-023
20.5 cm / 8"



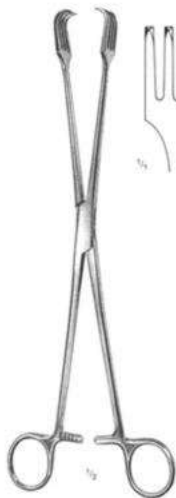

WFE-369-024
26.0 cm / 10 1/4"



Braun
WFE-369-025
16.0 cm / 6 1/4"



Czerny
WFE-369-026
21.0 cm / 8 1/4"





Kelly
WFE-370-001
32.0 cm / 12 1/2"

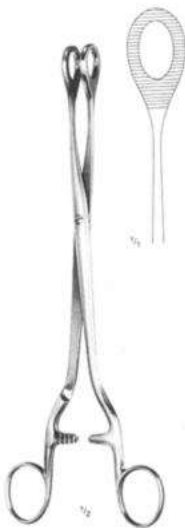

Noto
WFE-370-002
27.0 cm / 10 1/2"



Doyen
WFE-370-003
20.0 cm / 8"





Doyen
WFE-37-001
17.0 cm / 6 3/4"



Doyen
WFE-37-002
17.0 cm / 6 3/4"



Segond
WFE-37-003



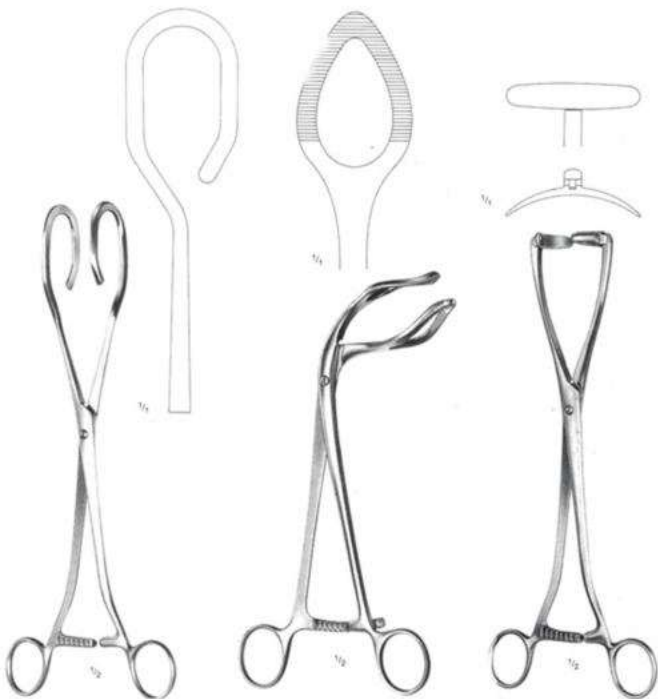

Dartingues
WFE-372-001
27.0 cm / 10 1/2"

Somer
WFE-372-002
23.0 cm / 9"

Colin
WFE-372-003
25.0 cm / 10"





Randall
WFE-373-001
24.0 cm / 9 1/2"
4 mm Ø



Novak
WFE-373-002
23.0 cm / 9"
4 mm Ø



Kevorkian
WFE-373-003
30.0 cm / 12"



Mod. Muenchen
WFE-373-004
27.0 cm / 10 1/2"

Biopsy Curette

* Endometrial Suction Biopsy Curettes



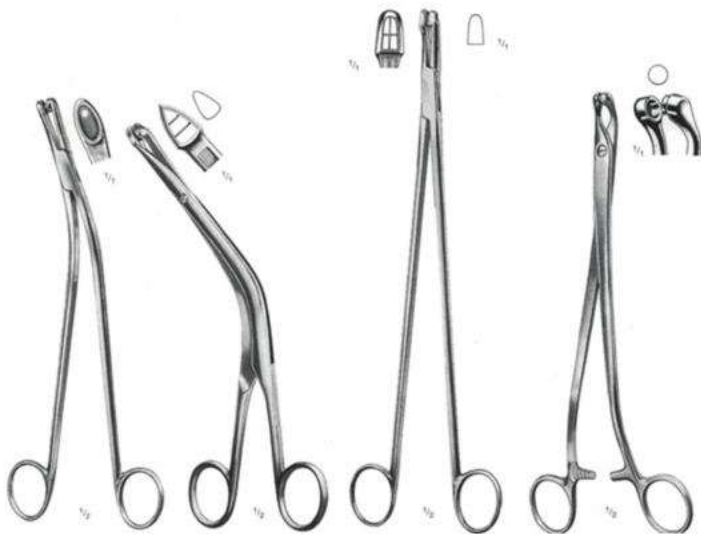

Cellham
WFE-374-001
23.0 cm / 9"

Faure
WFE-374-002
21.0 cm / 8 1/2"

Schubert
WFE-374-003 - 21.0 cm / 8 1/2"
WFE-374-004 - 29.0 cm / 11 1/2"

Thomas-Gaylor
WFE-374-005
24.0 cm / 9 1/2"



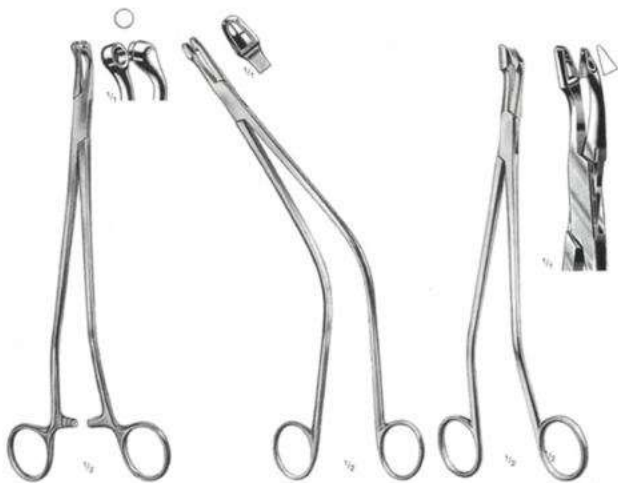

Thomas-Gaylor
WFE-375-006 - 22.0 cm / 8 1/2"
WFE-375-007 - 24.0 cm / 9 1/2"

Schubert
WFE-375-008
28.0 cm / 10 1/2"

Van Doren
WFE-375-009
24.0 cm / 9 1/2"



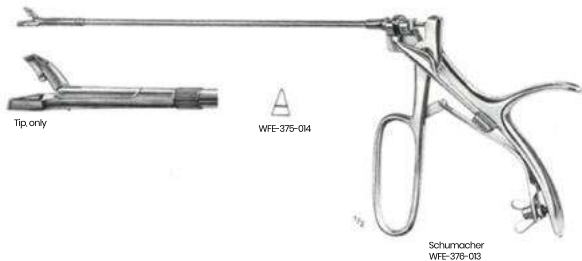
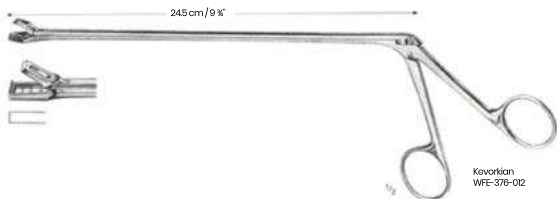
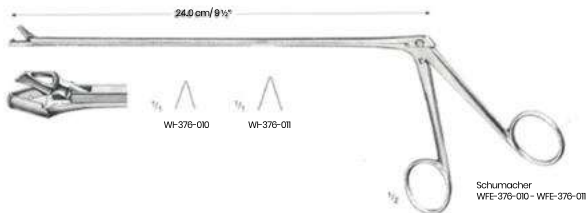



WFE-377-001



WFE-377-002



WFE-377-003



WFE-377-004



WFE-377-005



WFE-377-006



Simon
WFE-377-001 - WFE-377-006
25.0 cm / 10"

sharp, rigid



WFE-377-007



WFE-377-008



WFE-377-009



WFE-377-010



WFE-377-011



WFE-377-012



Schroeder
WFE-377-007 - WFE-377-012
30.0 cm / 12"

sharp, rigid





sharp



Recamier-Sims-Bumm
WFE-376-001
31.0 cm / 12 1/2"
Fig. 00-16
rigid

Recamier-Sims-Bumm
WFE-376-002
31.0 cm / 12 1/2"
Fig. 00-16
malleable

blunt



Recamier-Sims-Bumm
WFE-376-003
31.0 cm / 12 1/2"
Fig. 00-16
rigid

Recamier-Sims-Bumm
WFE-376-004
31.0 cm / 12 1/2"
Fig. 00-16
rigid



Sharp Curettes
(Recamier Handle)



Malleable Curettes
(grooved shaft)



Rigid Curettes
(plain shaft)



Blunt Curettes
(Sims Handle)



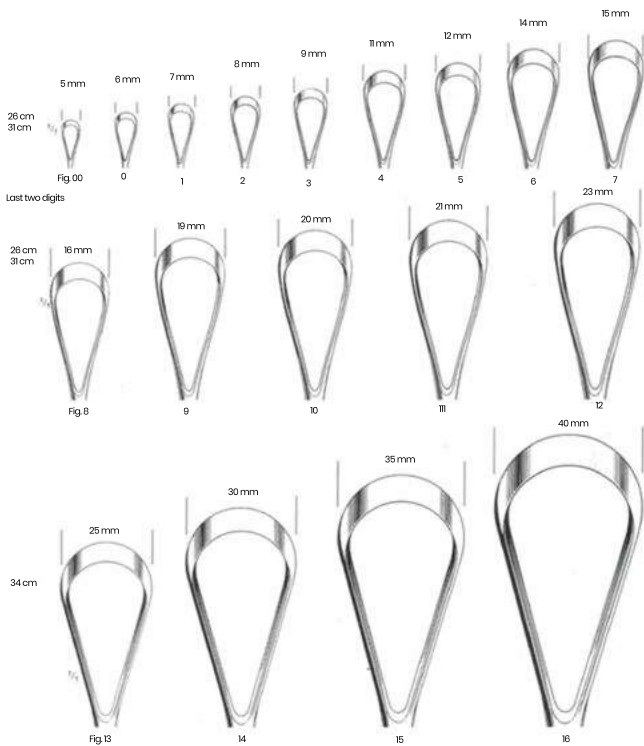

Recamier-Sims-Bumm





Special Model
WFE-380-001
34.0 cm / 13 1/2"
cm/inch scale



Collin
WFE-380-002
35.0 cm / 13 3/4"
cm scale



Briesky
WFE-380-003
33.0 cm / 13"
cm/inch scale



Naegle
WFE-380-004-38.0cm / 14"
WFE-380-005-40.0 cm / 16"



Simpson
WFE-380-005
30.0cm / 12"



Simpson-Braun
WFE-380-006
36.0cm / 14"



Simpson-Lulkart
WFE-380-008
36.0cm / 14"





De Lee
WFE-381-009
30.0 cm / 12"



De Lee
WFE-381-010 - 36.0 cm / 14"
WFE-381-011 - 39.0 cm / 15½"



Elliot
WFE-381-012
32.0 cm / 12½"
WFE-381-013
38.0 cm / 15"



Mc Lean
WFE-381-014
38.0 cm / 14"



Kjelland
WFE-381-015
41.0 cm / 16"



Kjelland-Lukart
WFE-381-016
40.0 cm / 15¾"



Piper
WFE-381-017
44.0 cm / 17¼"



Obstetrics Scalp Flap Forceps, Elevating Spoon, ETC.

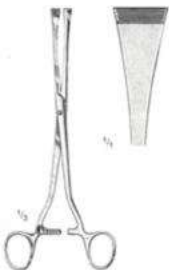

Green-Armytage
WFE-382-001
210 cm / 8 1/4"



Seilhaim
WFE-382-002
260 cm / 11"

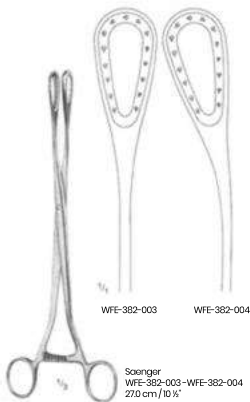

WFE-382-003

WFE-382-004

Sawenger
WFE-382-003 - WFE-382-004
27.0 cm / 10 1/4"

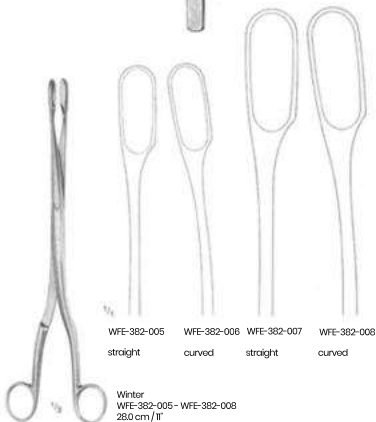

WFE-382-005

WFE-382-006

WFE-382-007

WFE-382-008

straight

curved

straight

curved

Winter
WFE-382-005 - WFE-382-008
26.0 cm / 11"





McKenzie
WFE-383-001 - 15.0 cm / 6"
WFE-383-002 - 19.0 cm / 7 1/2"



McKenzie
WFE-383-003 - 15.0 cm / 6"
WFE-383-004 - 19.0 cm / 7 1/2"

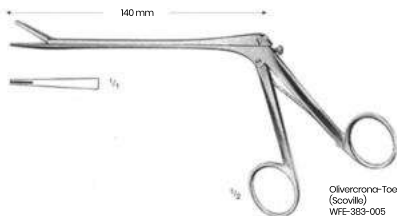

Olivercrona-Toennis
(Scoville)
WFE-383-005



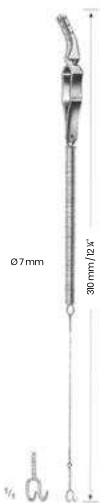
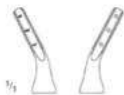
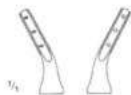

Yasargil
WFE-384-001
310 cm / 12 1/4"

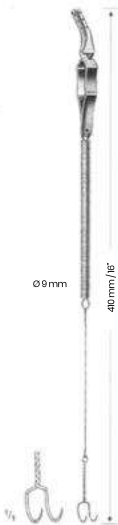

Yasargil
WFE-384-002
410 cm / 16"





Penfield
WFE-385-001
17.5 cm / 7"
Fig.1



Penfield
WFE-385-002
18.5 cm / 7 1/2"
Fig.2



Penfield
WFE-385-003
18.5 cm / 7 1/2"
Fig.3



Penfield
WFE-385-004
21.5 cm / 8 1/2"
Fig.4



Penfield
WFE-385-005
28.0 cm / 11 1/2"
Fig.5





Dcrvis
WFE-386-006
245 cm / 9 3/4"

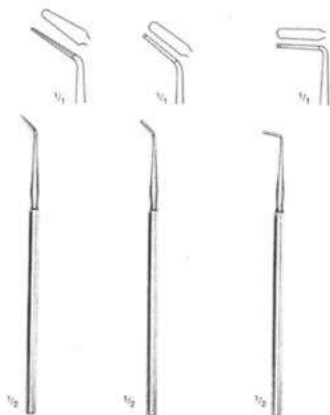

Frazier
WFE-386-007
15.0 cm / 6"

Hoen
WFE-386-008
15.0 cm / 6"

Hoen
WFE-386-009
15.0 cm / 6"





Love
WFE-387-010 - WFE-387-012



Horsley
WFE-387-013
20.0 cm / 8"

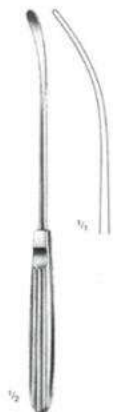

Sachs
WFE-387-014
21.0 cm / 8 1/4"





Heifetz
20.0 cm / 8"

Malleable

- WFE-388-001 - 8 mm
- WFE-388-002 - 11 mm
- WFE-388-003 - 14 mm
- WFE-388-004 - 17 mm
- WFE-388-005 - 20 mm



Cushing
WFE-388-006 - WFE-388-008

WFE-388-006
17.0 cm / 6 3/4"
8 x 10 mm

WFE-388-007
20.0 cm / 8"
13 x 15 mm

WFE-388-008
28.0 cm / 11"
16 x 18 mm



Oliverona
WFE-388-009 - WFE-388-016
18.0 cm / 7"



width of spatulas

concave	upper end mm	lower end mm	convex
WFE-388-009	7	9	WFE-388-013
WFE-388-010	11	13	WFE-388-014
WFE-388-011	15	18	WFE-388-015
WFE-388-012	18	22	WFE-388-016



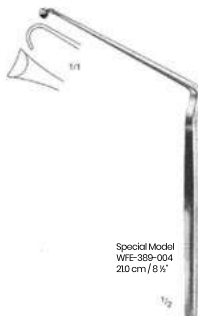
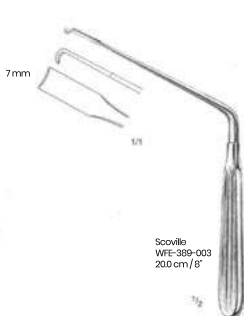



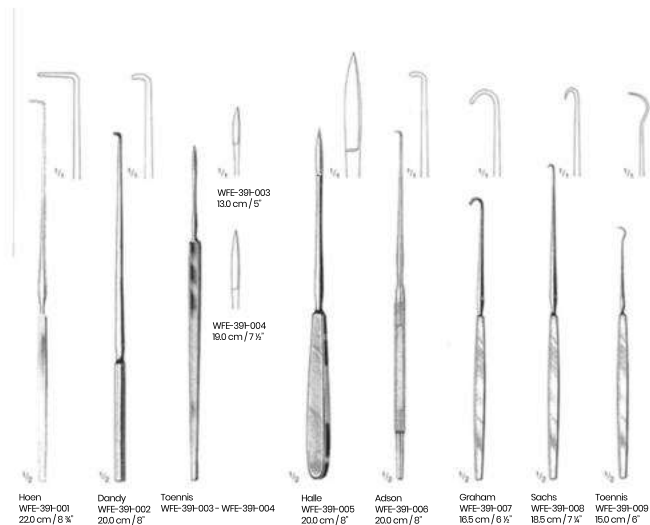



Lahy
WFE-392-010
13.0 cm / 5"



Cushing
WFE-392-011
14.0 cm / 5 1/2"



Frazier
WFE-392-012 - WFE-392-015



WFE-392-012
13.0 cm / 5"

sharp



WFE-392-014
13.0 cm / 5"

blunt



WFE-392-013
13.0 cm / 7"

sharp



WFE-392-015
13.0 cm / 7"

blunt



Adson
WFE-392-016
20.0 cm / 8"





Cloward
WFE-393-001
16.0 cm / 6 1/4"

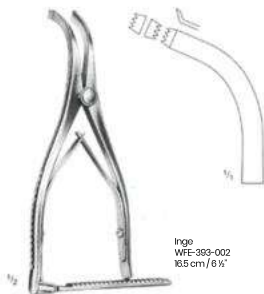

Ingo
WFE-393-002
16.5 cm / 6 1/2"

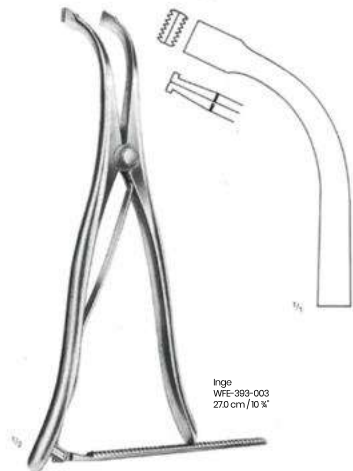

Ingo
WFE-393-003
27.0 cm / 10 3/4"



Neurosurgery Intervertebral Disc Rongeur With Exchangeable Tips



WFE-394-003
width of jaw 4 mm



WFE-394-004
width of jaw 5 mm



WFE-394-005
width of jaw 6 mm

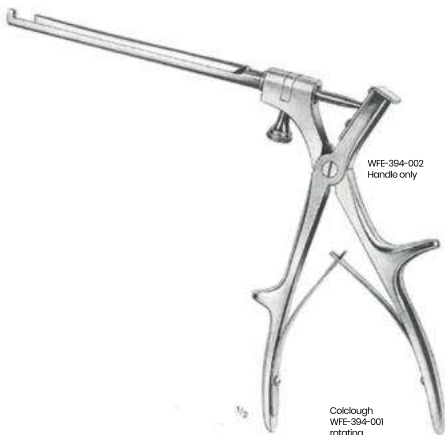

WFE-394-002
Handle only

Colclough
WFE-394-001
rotating

Consists of 3 interchangeable tips





Length of shaft	150 mm 6"	150 mm 6"	200 mm 8"	200 mm 8"
Width of bit	3 mm	5 mm	3 mm	5 mm
Cat. Ref.	WFE-395-001	WFE-395-002	WFE-395-003	WFE-395-004



Colclough
WFE-395-001 - WFE-395-002

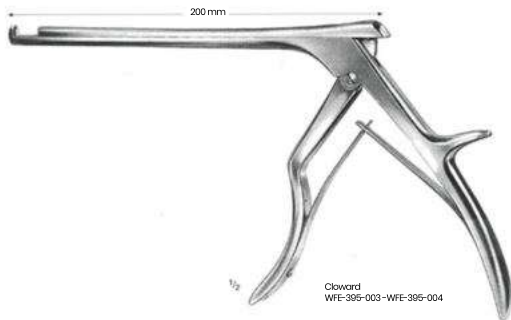

Cloward
WFE-395-003 - WFE-395-004





Length of shaft	150 mm 6"	150 mm 6"	200 mm 8"	200 mm 8"
Width of bite	3 mm	5 mm	3 mm	5 mm
Cat. Ref.	WFE-396-005	WFE-396-006	WFE-396-007	WFE-396-008

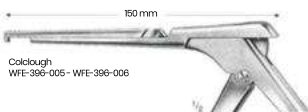

Colclough
WFE-396-005 - WFE-396-006

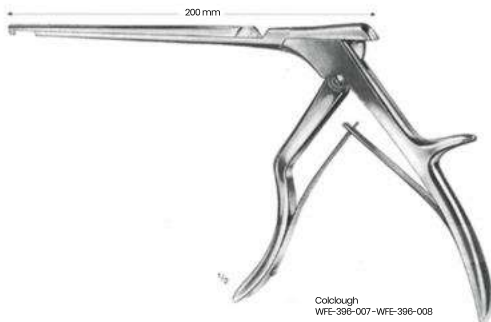

Colclough
WFE-396-007 - WFE-396-008





Length of shaft	150 mm 6"	150 mm 6"	200 mm 8"	200 mm 8"
Width of bite	3 mm	5 mm	3 mm	5 mm
Cat. Ref.	WFE-397-009	WFE-397-010	WFE-397-011	WFE-397-012



Colclough
WFE-397-009 - WFE-397-010

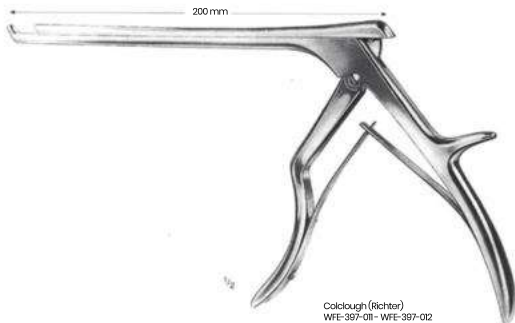

Colclough (Richter)
WFE-397-011 - WFE-397-012



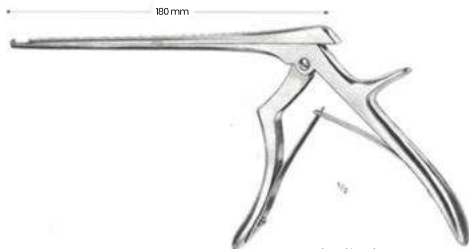









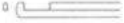
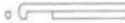

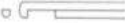



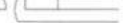

Forris-Smith-Korison
WFE-398-001-WFE-398-018
18.0 cm / 7 cm shaft

cutting upward

cutting downward

cutting 40° forward

	WFE-398-001 1 mm		WFE-398-007 1 mm		WFE-398-013 1 mm
	WFE-398-002 2 mm		WFE-398-008 2 mm		WFE-398-014 2 mm
	WFE-398-003 3 mm		WFE-398-009 3 mm		WFE-398-015 3 mm
	WFE-398-004 4 mm		WFE-398-010 4 mm		WFE-398-016 4 mm
	WFE-398-005 5 mm		WFE-398-011 5 mm		WFE-398-017 5 mm
	WFE-398-006 6 mm		WFE-398-012 6 mm		WFE-398-018 6 mm



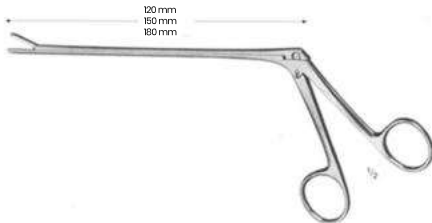

Cushing (WFE-399-001 - WFE-399-009)
2mm



2 x 10 mm
WFE-399-001 - 12.0 cm
WFE-399-002 - 15.0 cm
WFE-399-003 - 18.0 cm



2 x 10 mm / 45°
WFE-399-004 - 12.0 cm
WFE-399-005 - 15.0 cm
WFE-399-006 - 18.0 cm



2 x 10 mm / 45°
WFE-399-007 - 12.0 cm
WFE-399-008 - 15.0 cm
WFE-399-009 - 18.0 cm

Love-Gruenwald (WFE-399-010 - WFE-399-018)
3mm



3 x 10 mm
WFE-399-010 - 12.0 cm
WFE-399-011 - 15.0 cm
WFE-399-012 - 18.0 cm



3 x 10 mm / 45°
WFE-399-013 - 12.0 cm
WFE-399-014 - 15.0 cm
WFE-399-015 - 18.0 cm



3 x 10 mm / 45°
WFE-399-016 - 12.0 cm
WFE-399-017 - 15.0 cm
WFE-399-018 - 18.0 cm

Spurling (WFE-399-019 - WFE-399-027)
4mm



4 x 10 mm
WFE-399-019 - 12.0 cm
WFE-399-020 - 15.0 cm
WFE-399-021 - 18.0 cm



4 x 10 mm / 45°
WFE-399-022 - 12.0 cm
WFE-399-023 - 15.0 cm
WFE-399-024 - 18.0 cm



4 x 10 mm / 45°
WFE-399-025 - 12.0 cm
WFE-399-026 - 15.0 cm
WFE-399-027 - 18.0 cm



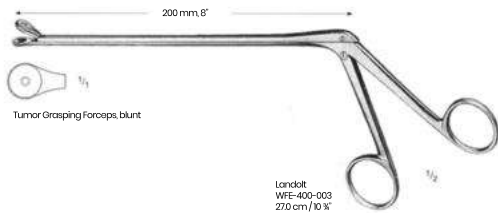
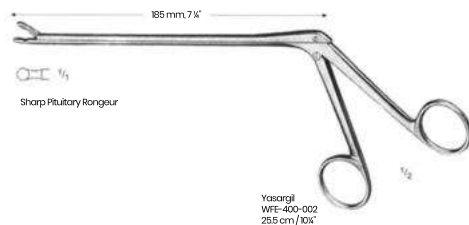
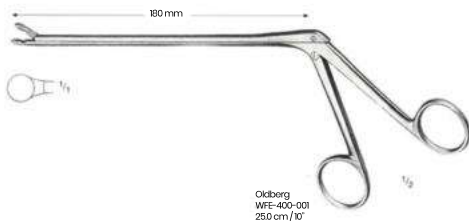

Neurosurgery Laminectomy Rongeurs



Kerrison Rongeurs

18.0 cm / 7" shaft
WFE-401-001-WFE-401-010

90° Up-bite

90° Down-bite

WFE-401-001	WFE-401-008	2mm bite
WFE-401-002	WFE-401-007	3mm bite
WFE-401-003	WFE-401-008	4mm bite
WFE-401-004	WFE-401-009	5mm bite
WFE-401-005	WFE-401-010	6mm bite

Kerrison Rongeurs

20.0 cm / 8" shaft
WFE-401-011-WFE-401-020

90° Up-bite

90° Down-bite

WFE-401-011	WFE-401-018	2mm bite
WFE-401-012	WFE-401-017	3mm bite
WFE-401-013	WFE-401-018	4mm bite
WFE-401-014	WFE-401-019	5mm bite
WFE-401-015	WFE-401-020	6mm bite

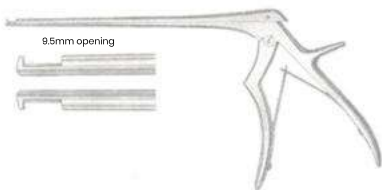

Kerrison Rongeurs

18.0 cm / 8" shaft, 40° forward-angle
WFE-401-021-WFE-401-025

WFE-401-021	2mm bite	WFE-401-024	5mm bite
WFE-401-022	3mm bite	WFE-401-025	6mm bite
WFE-401-023	4mm bite		

Kerrison Rongeurs

20.0 cm / 8" shaft, 40° forward-angle
WFE-401-026-WFE-401-030

WFE-401-026	2mm bite	WFE-401-029	5mm bite
WFE-401-027	3mm bite	WFE-401-030	6mm bite
WFE-401-028	4mm bite		

Kerrison Rongeurs

23.0 cm / 8" shaft, 40° forward-angle
WFE-401-031-WFE-401-035

WFE-401-031	2mm bite	WFE-401-034	5mm bite
WFE-401-032	3mm bite	WFE-401-035	6mm bite
WFE-401-033	4mm bite		

Kerrison Rongeurs

25.0 cm / 10" shaft, 40° forward-angle
WFE-401-036-WFE-401-040

WFE-401-036	2mm bite	WFE-401-039	5mm bite
WFE-401-037	3mm bite	WFE-401-040	6mm bite
WFE-401-038	4mm bite		

Kerrison Rongeurs

28.0 cm / 11" shaft, 40° forward-angle
WFE-401-041-WFE-401-045

WFE-401-041	2mm bite	WFE-401-044	5mm bite
WFE-401-042	3mm bite	WFE-401-045	6mm bite
WFE-401-043	4mm bite		

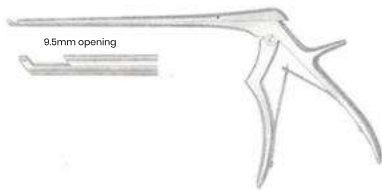

Neurosurgery Laminectomy Rongeurs



Love-Kerrison Rongeurs 41° forward-angle WFE-402-001-WFE-402-010

18.0 cm / 7" shaft	20.0 cm / 8" shaft
WFE-402-001	WFE-402-006 2mm bite
WFE-402-002	WFE-402-007 3mm bite
WFE-402-003	WFE-402-008 4mm bite
WFE-402-004	WFE-402-009 5mm bite
WFE-402-005	WFE-402-010 6mm bite

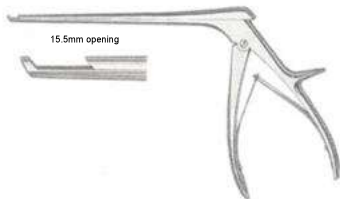

Love-Kerrison Rongeurs improved handle, 90° up-bite WFE-402-011-WFE-402-020

18.0 cm / 7" shaft	20.0 cm / 8" shaft
WFE-402-011	WFE-402-016 2mm bite
WFE-402-012	WFE-402-017 3mm bite
WFE-402-013	WFE-402-018 4mm bite
WFE-402-014	WFE-402-019 5mm bite
WFE-402-015	WFE-402-020 6mm bite

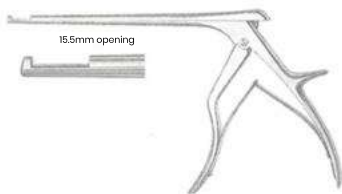

Love-Kerrison Rongeurs improved handle, 40° forward-angle WFE-402-021-WFE-402-040

18.0 cm / 7" shaft	20.0 cm / 8" shaft	23.0 cm / 9" shaft	28.0 cm / 11" shaft
WFE-402-021	WFE-402-026	WFE-402-031	WFE-402-036 2mm bite
WFE-402-022	WFE-402-027	WFE-402-032	WFE-402-037 3mm bite
WFE-402-023	WFE-402-028	WFE-402-033	WFE-402-038 4mm bite
WFE-402-024	WFE-402-029	WFE-402-034	WFE-402-039 5mm bite
WFE-402-025	WFE-402-030	WFE-402-035	WFE-402-040 6mm bite

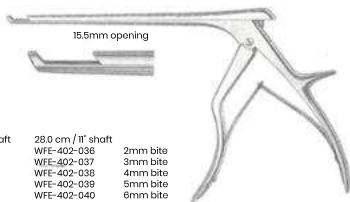

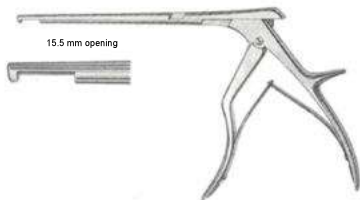

Love-Kerrison Rongeur
improved handle, 20.0 cm / 8" shaft
90° down-bite
WFE-403-001-WFE-403-005

WFE-403-001	2mm bite
WFE-403-002	3mm bite
WFE-403-003	4mm bite
WFE-403-004	5mm bite
WFE-403-005	6mm bite

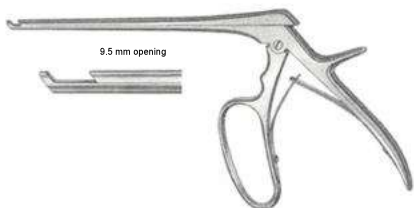

Laminectomy Rongeurs
40° forward angle
WFE-403-006-WFE-403-009

17.5cm / 6 7/8" shaft	20.0 cm / 8" shaft	
WFE-403-006	WFE-403-008	3mm bite
WFE-403-007	WFE-403-009	5mm bite

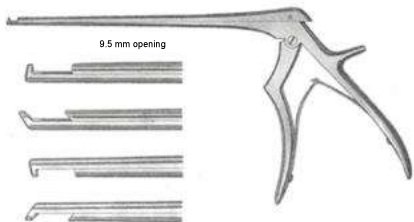

Sella Punches
18.0 cm / 7" shaft 2mm bite
WFE-403-010-WFE-403-013

WFE-403-010	90° up-bite
WFE-403-011	40° up-bite
WFE-403-012	90° down-bite
WFE-403-013	40° down-bite



Neurosurgery Laminectomy Rongeurs



Schiesinger Rongeur
13.0 cm / 5" shaft, serrated jaws, straight
WFE-404-001-WFE-404-004

- WFE-404-001 2 x 10mm bite
- WFE-404-002 3 x 10mm bite
- WFE-404-003 4 x 10mm bite
- WFE-404-004 3 x 10mm bite, up up angled



Special Model
13.0 cm / 5" shaft, serrated jaws
8 x 10mm bite
WFE-404-001-WFE-404-004

- WFE-404-005 Straight
- WFE-404-006 Up-angled
- WFE-404-007 Down-angled

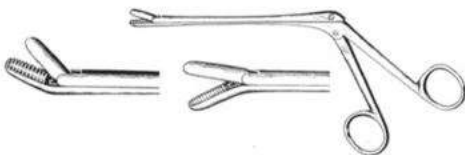

wilde Rongeurs
fenestrated jaws, straight
WFE-404-008-WFE-404-016

- | | | | |
|------------------------|--------------------|--------------------|----------|
| 14.0 cm / 5 1/2" shaft | 18.0 cm / 7" shaft | 23.0 cm / 9" shaft | |
| WFE-404-008 | WFE-404-011 | WFE-404-014 | 4mm bite |
| WFE-404-009 | WFE-404-012 | WFE-404-015 | 5mm bite |
| WFE-404-010 | WFE-404-013 | WFE-404-016 | 6mm bite |



wilde Rongeurs
fenestrated jaws, up-angled
10.8 cm / 4 1/4" shaft, 5mm bite
WFE-404-017





Jackson Rongeur
18.0 cm / 7" shaft, fenestrated jaws

WFE-405-001 4 x 8mm bite, 70° up-angled



Peapod (Bead-Type) Forceps
14.0 cm / 5 1/2" shaft 45° up angled
WFE-405-002-WFE-405-004

WFE-405-002 2.3 x 7mm bite
WFE-405-003 2.7 x 7mm bite
WFE-405-004 3.2 x 7mm bite



Takahashi Rongeur
13.0 cm / 5" shaft, 4 x 10mm bite
WFE-405-005



Neurosurgery Intervertebral Disc Rongeurs



Ferris-Smith Cup Jaw Rongeurs
18.0 cm / 7" shaft, straight

WFE-406-006	2 x 10mm bite
WFE-406-007	3x 10mm bite
WFE-406-008	4 x 10mm bite
WFE-406-009	4 x 8mm bite
WFE-406-010	6 x 10mm bite
WFE-406-011	6 x 12mm bite

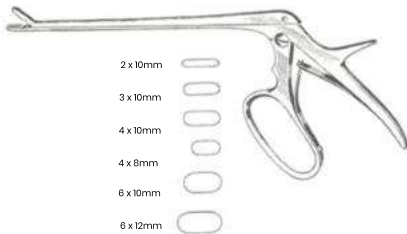

Ferris-Smith Cup Jaw Rongeurs
18.0 cm / 7" shaft, up-angled

WFE-406-012	2 x 10mm bite
WFE-406-013	3x 10mm bite
WFE-406-014	4 x 10mm bite
WFE-406-015	6 x 10mm bite

2 x 10mm



Ferris-Smith Cup Jaw Rongeurs
18.0 cm / 7" shaft, up-angled

WFE-406-016	2 x 10mm bite
WFE-406-017	3x 10mm bite
WFE-406-018	4 x 10mm bite



Stookey Carnial Rongeur
19.0 cm 7 1/8" 3mm bite
WFE-4060-019





WFE-407-001-WI-407-005

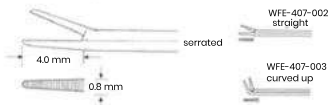
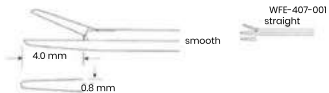

WFE-407-004
right

WFE-407-005
left

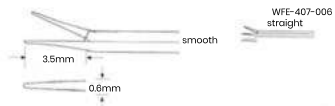

Mini McGee Alligator
WFE-407-006-WFE-407-007

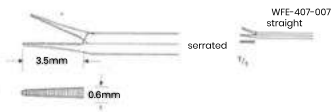



WFE-408-008

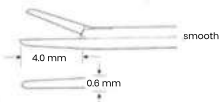

WFE-408-008
4.0 x 0.6 mm
straight

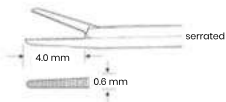

WFE-408-009
4.0 x 0.6 mm
straight



WFE-408-009-WFE-408-012

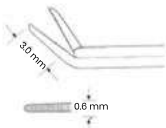

WFE-408-010
3.0 x 0.6 mm
curved up

WFE-408-011
3.0 x 0.6 mm
right

WFE-408-012
3.0 x 0.6 mm
left





WFE-409-013-WFE-409-016

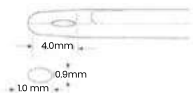

WFE-409-013
straight



WFE-409-014
curved up



WFE-409-015
right

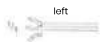

left



WFE-409-017-WFE-409-020

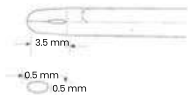

WFE-409-017
straight



WFE-409-018
curved up



WFE-409-019
right



WFE-409-020
left



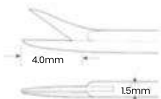
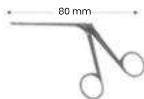

WFE-410-021
straight

WFE-410-022
curved up

WFE-410-023
right

WFE-410-024
left



Bellucci
WFE-410-021-WFE-410-024

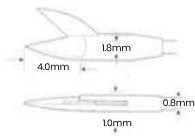

WFE-410-025
straight

WFE-410-026
curved up

WFE-410-027
right

WFE-410-028
left



Wullstein
WFE-410-025-WFE-410-028





Greven
WFE-411-029



Schuknecht
WFE-411-030

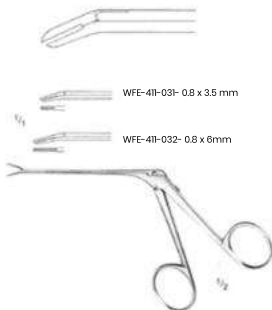

McGee
WFE-411-032- WFE-411-032



Juers
WFE-411-033- WFE-411-034

WFE-411-031- 0.8 x 3.5 mm

WFE-411-032- 0.8 x 6mm

WFE-411-033
left

WFE-411-034
right





WFE-412-035

WFE-412-036



House-Dieter
WFE-412-035-WFE-412-036

WFE-412-037 left

WFE-412-038 right



House-Dieter
WFE-412-037-WFE-412-038



Fuuler
WFE-412-039

*Instruments for introducing teflon pistons





Schuknech
WFE-413-001

Roller knife



Schuknech
WFE-413-002

Roller knife



Schuknech
WFE-413-003

Sickle knife



Wullstein®
WFE-413-004

Sickle knife



Tabb
WFE-413-005

Sickle knife



Plester
WFE-413-006



WFE-413-007
3 mm



WFE-413-008
2.8 mm



WFE-413-009
2.6 mm



WFE-413-010
2 mm



WFE-413-011
1.8mm



WFE-413-012
1.4mm



WFE-413-013
1mm

Rosen (Round knives)
WFE-413-007-WFE-413-013



Otology Needles, Picks and Hooks, Straight Shaft



Barbara
WFE-414-001



WFE-414-002



WFE-414-003



Rosen
WFE-414-004



Barbara
WFE-414-005-WFE-414-023



WFE-414-005-0.3 mm
WFE-414-006-06 mm
WFE-414-007-1.0 mm



WFE-414-008- 0.3 mm
WFE-414-009- 06 mm
WFE-414-010-1.0 mm
WFE-414-011- 1.2 mm
WFE-414-012- 1.5 mm
WFE-414-013- 2.0 mm
WFE-414-014-2.5 mm



WFE-414-015- 0.3 mm
WFE-414-016- 06 mm
WFE-414-017-1.0 mm
WFE-414-018- 1.2 mm
WFE-414-019- 1.5 mm
WFE-414-020- 2.0 mm
WFE-414-021-2.5 mm



WFE-414-022- 0.5 mm
WFE-414-023- 1.0 mm





① mm Ø
=3
WFE-415-001

① mm Ø
=4.0
WFE-415-002

② mm Ø
=5.0
WFE-415-003



Hartmann
for children

	Pieces	Fig.	
Set of 3	0-2	WFE-415-004	

① mm Ø
=4.0
WFE-415-005

② mm Ø
=5.0
WFE-415-006

③ mm Ø
=6.0
WFE-415-007

④ mm Ø
=7.5
WFE-415-008



Hartmann
for adults

	Pieces	Fig.	
Set of 3	2-4	WFE-415-009	
Set of 4	1-4	WFE-415-010	

① mm Ø
=4.0
WFE-415-011

② mm Ø
=5.0
WFE-415-012

③ mm Ø
=6.0
WFE-415-013

④ mm Ø
=7.5
WFE-415-014



Toynbee
for adults

	Pieces	Fig.	
Set of 3	2-4	WFE-415-015	
Set of 4	1-4	WFE-415-016	

① mm Ø
=4.5
WFE-415-017

② mm Ø
=5.5
WFE-415-018

③ mm Ø
=6.5
WFE-415-019

④ mm Ø
=7.5
WFE-415-020



Gruber
for adults

	Pieces	Fig.	
Set of 3	2-4	WFE-415-021	

① mm Ø
=4.5
WFE-415-022

② mm Ø
=5.5
WFE-415-023

③ mm Ø
=6.5
WFE-415-024

④ mm Ø
=7.5
WFE-415-025



Gruber
for adults

	Pieces	Fig.	
Set of 4	1-4	WFE-415-026	

5.5 x
8.5 mm
WFE-415-027

5.5 x
7.5 mm
WFE-415-028

5.5 x
8.5 mm
WFE-415-029

5.5 x
9.5 mm
WFE-415-030



Zollner
for adults

	Pieces	Fig.	
Set of 6		WFE-415-033	

5.5 x
10.5 mm
WFE-415-031

Aluminium black
WFE-415-032



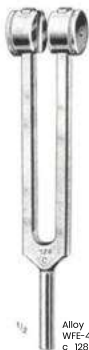

Alloy
WFE-416-001
c¹ 128



Alloy
WFE-416-002
c¹ 256



Alloy
WFE-416-003
c¹ 512



Alloy
WFE-416-004
c² 1024



Alloy
WFE-416-005
c⁴ 1248



Hartmann
WFE-416-006
c¹ 128



Hartmann
WFE-416-007
c¹ 256



Hartmann
WFE-416-008
c² 512



Hartmann
WFE-416-009
c² 1024



Hartmann
WFE-416-010
c⁴ 2048



Hartmann
WFE-416-011
c³ 4096





Krause
 WFE-417-001



Krause-Voss
 WFE-417-002



Troeltsch (Wildle)
 WFE-417-003
 11.0 cm / 4 1/4"



Troeltsch (Wildle)
 WFE-417-004
 12.0 cm / 4 3/4"



Troeltsch (Wildle)
 WFE-417-005
 13.0 cm / 5"



Lucae
 WFE-417-006
 14.0 cm / 5 1/2"



Jönson
 WFE-417-007 - 16.0 cm / 6 1/4"
 WFE-417-008 - 20.0 cm / 8"





Litauer
WFE-418-001
12.0 cm / 4 3/4"



Hartmann
WFE-418-002
12.0 cm / 4 3/4"
fine pattern



Hartmann
WFE-418-003
14.0 cm / 5 1/2"
standard pattern

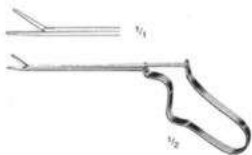

Buck
WFE-418-004



Quire
WFE-418-005





Hartmann-Wullstein
WFE-419-001
8.5 cm / 3 1/2"

○ 1 mm



Hartmann-Wullstein
WFE-419-002
8.5 cm / 3 1/2"



Hartmann
WFE-419-003-8.5 cm / 3 1/2"
WFE-419-004-8.5 cm / 5 1/2"
WFE-419-005-8.5 cm / 6 1/2"



Hartmann
WFE-419-006-8.5 cm / 3 1/2"
WFE-419-007-14.0 cm / 5 1/2"



Hartmann-Noyes
WFE-419-008-8.0 cm / 3 1/4"



Hartmann-Noyes
WFE-419-009-8.0 cm / 3 1/4"



Hartmann-Weingartner
WFE-419-010-8.5 cm / 3 1/2"



Hartmann
WFE-419-011-8.5 cm / 3 1/2"

○ 2 mm

○ 2.5 mm

○ 3 mm



Hartmann
WFE-419-012-2 mm Ø
WFE-419-013-2.5 mm Ø
WFE-419-014-3 mm Ø



Hartmann
WFE-419-015
8.5 cm / 3 1/2"



Struempel
WFE-419-016
8.5 cm / 3 1/2"



Hartmann
WFE-419-017
8.5 cm / 3 1/2"



WFE-419-001-WFE-419-019



Hartmann
WFE-419-018
8.5 cm / 3 1/2"

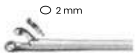

○ 2 mm

Hartmann-Hoffmann
WFE-419-019
8.5 cm / 3 1/2"





Citelli
WFE-420-001



Beyer
WFE-420-002



Beyer
WFE-420-003





Langenbeck
WFE-421-001
13.3 cm / 5 1/8"



Shapleigh
WFE-421-002-WFE-421-005
13.3 cm / 5 1/8"



WFE-421-002



WFE-421-003



WFE-421-004



WFE-421-005



Buck
WFE-421-006-WFE-421-019
16.5 cm / 6 1/2"



blunt



sharp



000

WFE-421-006



00

WFE-421-007



0

WFE-421-008



1

WFE-421-009



2

WFE-421-010



3

WFE-421-011



4

WFE-421-012



000

WFE-421-013



00

WFE-421-014



0

WFE-421-015



1

WFE-421-016



2

WFE-421-017



3

WFE-421-018



4

WFE-421-019



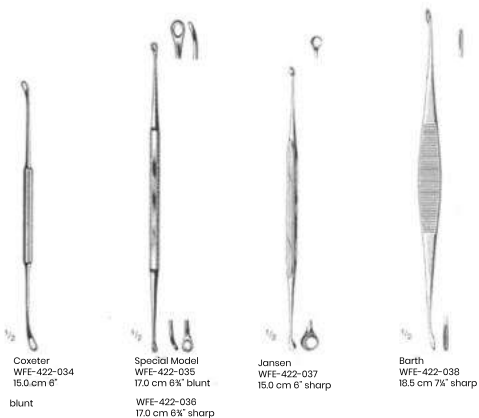
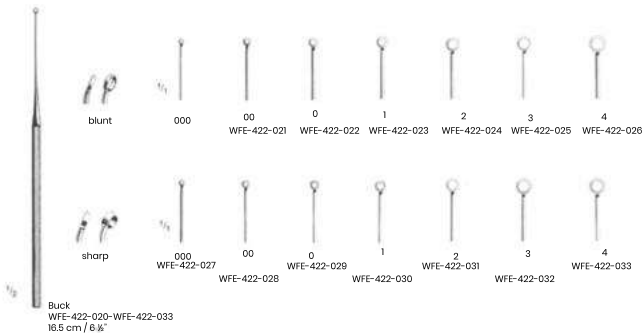



Gross
WFE-423-001
12.0 cm / 4 3/4"
blunt



WFE-423-002-WFE-423-003
16.0 cm / 6 1/4"



WFE-423-002



WFE-423-003



Billeau
WFE-423-004-WFE-423-006
16.4 cm / 6 1/2"



WFE-423-004



WFE-423-005



WFE-423-006



Moldenhauer
WFE-423-007
16.5 cm / 6 1/2"



Zauffel
WFE-423-008
16.0 cm / 6 1/4"



Hartman
WFE-423-009
16.0 cm / 6 1/4"



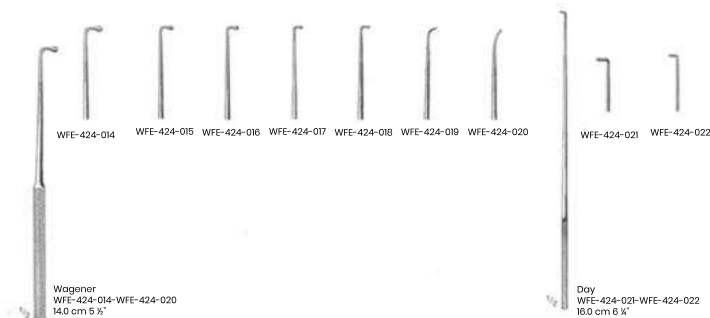
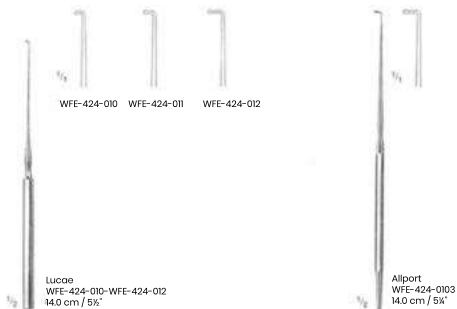

Otology Elevators, Raspatories, Curettes ETC.

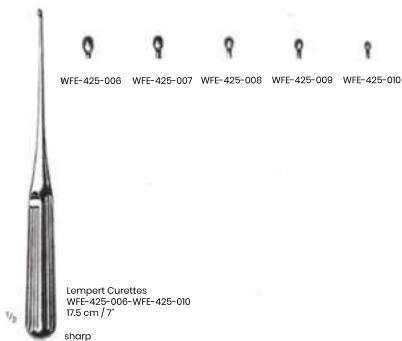
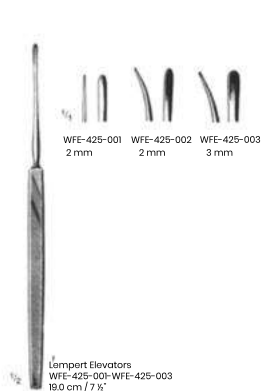



Heister
WFE-426-001
13.0 cm / 5"



Molt
WFE-426-002
11.0 cm / 4 1/2"



Molt
WFE-426-003
14.0 cm / 5 1/2"



Denhart
WFE-426-004
12.0 cm / 4 3/4"



Roser-Konig
WFE-426-005-16.0 cm / 6 1/4"
WFE-426-006-19.0 cm / 7 1/2"





Whitehead
WFE-427-007-11.0 cm / 4 1/4"
WFE-427-008-13.0 cm / 5"
WFE-427-009-15.0 cm / 6"

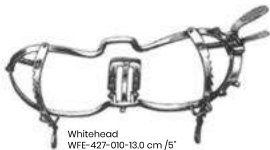

Whitehead
WFE-427-010-13.0 cm / 5"

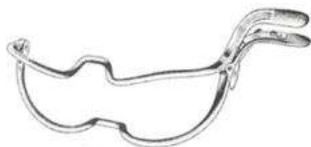

Jennings
WFE-427-011- 9.0 cm / 3 1/2"
WFE-427-012- 1.0 cm / 4 1/2"
WFE-427-013 - 13.0 cm / 5"
WFE-427-014 - 15.0 cm / 6"

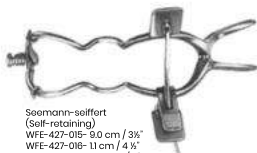

Seemann-soiffert
(Self-retaining)
WFE-427-015- 9.0 cm / 3 1/2"
WFE-427-016- 11 cm / 4 1/2"
WFE-427-017 - 13.0 cm / 5"
WFE-427-018 - 15.0 cm / 6"

Tongue Depressors



Kilner- Doughty
Complete with frame
WFE-427-019

Gag
WFE-427-020



WFE-427-021
Fig.1



WFE-427-022
Fig.2



WFE-427-023
Fig.3





WFE-428-024

Davis-Byle
WFE-428-030
complete with 6 blades

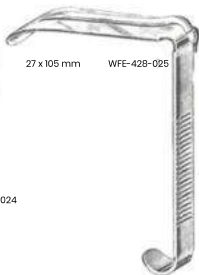

27 x 105 mm WFE-428-025



25 x 90 mm WFE-428-026



25 x 75 mm WFE-428-027



22 x 80 mm WFE-428-028



20 x 25 mm WFE-428-029



WFE-428-031

MCIVOR
WFE-428-035
complete with 3 blades



27 x 95 mm WFE-428-032



22 x 85 mm WFE-428-033



22 x 70 mm WFE-428-034



Oral and Facial Surgery

Mouth Gags and Tongue Holding Forceps

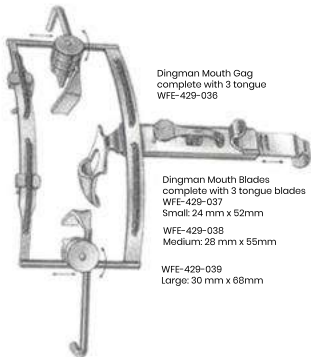

Dingman Mouth Gag
complete with 3 tongue
WFE-429-036

Dingman Mouth Blades
complete with 3 tongue blades
WFE-429-037
Small: 24 mm x 52mm
WFE-429-038
Medium: 28 mm x 55mm

WFE-429-039
Large: 30 mm x 68mm



Collin
WFE-429-040
17.0 cm / 6 3/4"



Guy
WFE-429-041
19.0 cm / 7 1/2"



Young
WFE-429-042
17.0 cm / 6 3/4"



WFE-429-043
pair



Oral and Facial Surgery Tongue Depressors



Moritz-Schmidt
WFE-430-001
19.0 cm / 7½"



Hartmann
WFE-430-002
15.0 cm / 6"



Tobold
WFE-430-003
14.0 cm / 5½"



Tobold
WFE-430-004
14.0 cm / 5½"



Andrew
WFE-430-005
11.0 cm / 4½"



WFE-430-006
14.0 cm / 5½"



WFE-430-007
15.0 cm / 6"

Wieder
WFE-430-006-WFE-430-007



Oral and Facial Surgery Tongue Depressors

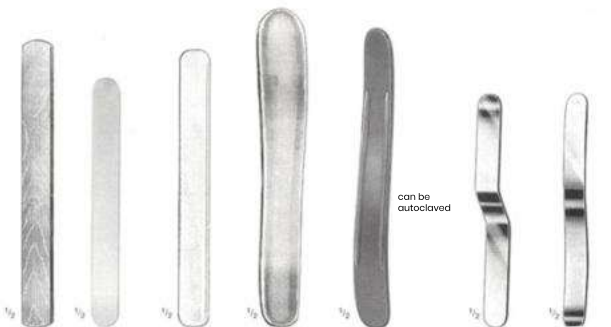

WFE-431-008
16.0 cm / 6 1/4"
of wood

WFE-431-009
15.0 cm / 6"
of plastic

Haas
WFE-431-010
16.0 cm / 6 1/4"
of acrylic glass

Buchwald
WFE-431-011
17.0 cm / 6 3/4"
of acrylic glass

Boilable
WFE-431-012
18.5 cm / 7 1/2"

can be
autoclaved

WFE-431-013
14.5 cm / 5 3/4"

WFE-431-014
14.5 cm / 5 3/4"

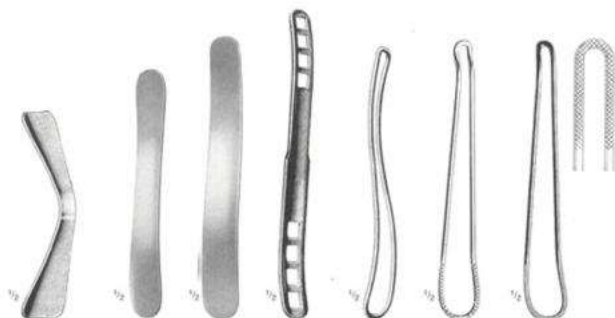

Doyen
WFE-431-015- 13.0 cm / 5"
WFE-431-016- 16.0 cm / 6 1/4"

Kroening
WFE-431-017
15.0 cm / 6"

Mayo
WFE-431-018
17.0 cm / 6 3/4"

Bruenings
WFE-431-019
18.0 cm / 7 1/2"

Collin
WFE-431-020
16.5 cm / 6 1/2"

Special Model
WFE-431-021
16.5 cm / 6 1/2"

Frenzel
WFE-431-022
16.5 cm / 6 1/2"





Obwegeser
(Kocher-Langenbeck)
WFE-432-001-WFE-432-006
21.5 cm / 8 1/2"



Obwegeser
WFE-432-001-WFE-432-009
22.0 cm / 8 3/4"



Oral and Facial Surgery Chin Retractors and Chanelled Retractors, Remus Retractors



Obwegeser
WFE-433-010
16.0 cm / 6 1/4"



Obwegeser
WFE-433-011 - 8mm
WFE-433-012 - 10mm
16.0 cm / 6 1/4"

10 x 42 mm



Obwegeser
WFE-433-013
22.0 cm / 8 1/4"

11 x 70 mm



Obwegeser
WFE-433-014
22.0 cm / 8 1/4"





8 mm
WFE-434-001

7 mm
WFE-434-002

9 mm
WFE-434-003

11 mm
WFE-434-004

Obwegeser
WFE-434-001-WFE-434-004
17.5 cm / 7"

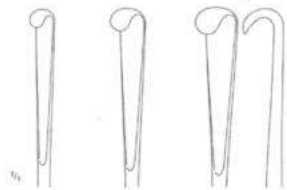

5 mm
WFE-434-005

7 mm
WFE-434-006

9 mm
WFE-434-007

Obwegeser
WFE-434-005-WFE-434-007
20.0 cm / 8"



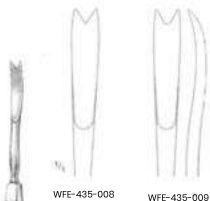

Obwegeser
WFE-435-008-WFE-435-009
17.5 cm / 7"

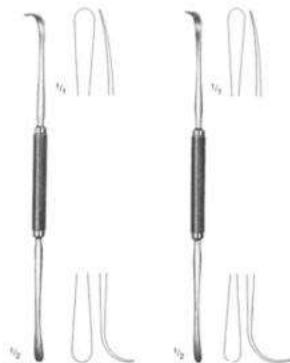

Obwegeser
WFE-435-010
21.0 cm / 8 1/4"

Obwegeser
WFE-435-011
21.0 cm / 8 1/4"

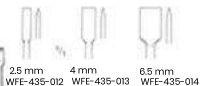

Obwegeser
WFE-435-012-WFE-435-014
15.0 cm / 6"



Obwegeser
WFE-435-015
21.5 cm / 9 1/4"



Obwegeser
WFE-435-016-WFE-435-017
18.5 cm / 7 1/4"





Obwogeser
WFE-435-018-18.0 cm / 7"
WFE-435-019-28.0 cm / 11"



Obwogeser
WFE-435-020
13.0 cm / 5"

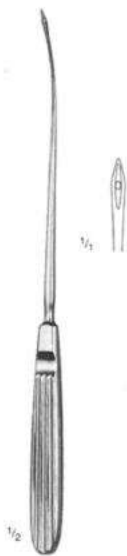

Obwogeser
WFE-435-021
23.0 cm / 9"





WFE-437-001
WFE-437-004

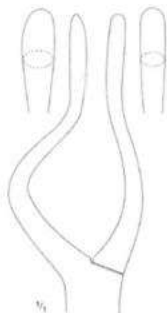

WFE-437-002
WFE-437-005

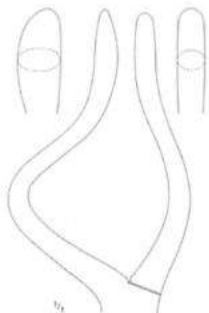

WFE-437-003
WFE-437-006



Rowe
WFE-437-001-WFE-437-003



Rowe
WFE-437-004-WFE-437-006





Fisher
WFE-438-001
23.0 cm / 9"



Abraham
WFE-438-002
21.0 cm / 8 1/4"



Bruenings
WFE-438-003
23.0 cm / 9"





Carpenter
WFE-439-004
25.0 cm / 10"



Carpenter
WFE-439-005
24.0 cm / 9 1/2"



Hurd
WFE-439-006
23.0 cm / 9"



Henke
WFE-439-007
23.0 cm / 9"



Henke
WFE-439-008
23.0 cm / 9"



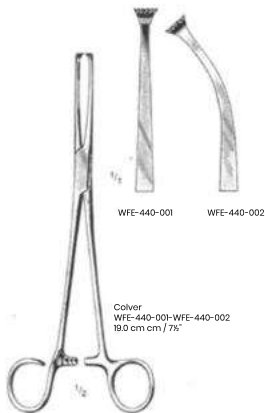

WFE-440-001

WFE-440-002

Colver
WFE-440-001-WFE-440-002
19.0 cm cm / 7 1/2"

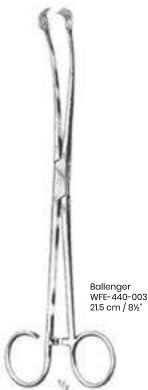

Ballenger
WFE-440-003
21.5 cm / 8 1/2"

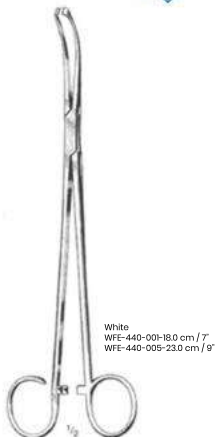

White
WFE-440-001-18.0 cm / 7"
WFE-440-005-23.0 cm / 9"

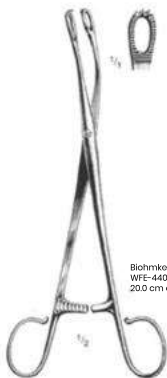

Biohmke
WFE-440-006
20.0 cm cm / 8"

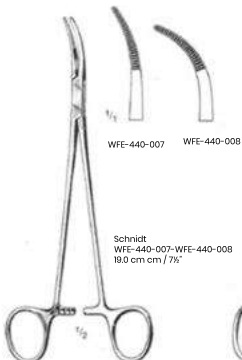

WFE-440-007

WFE-440-008

Schnidt
WFE-440-007-WFE-440-008
19.0 cm cm / 7 1/2"



WFE-440-009

WFE-440-010

Schnidt
WFE-440-009-WFE-440-010
19.0 cm cm / 7 1/2"



Oral and Facial Surgery Tonsil Snares



WFE-441-001-40mm
WFE-441-002-50mm



WFE-441-003
0.3 mm Ø



Eves
WFE-441-004
28.0 cm / 11"



Eves
WFE-441-005
28.0 cm / 11"



Bruenings
WFE-441-006
28.0 cm / 11"

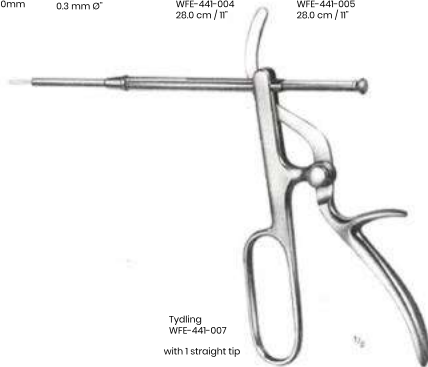

Tydling
WFE-441-007
with 1 straight tip



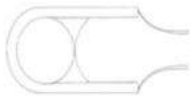

Fig. 1

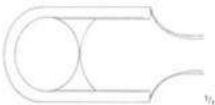

Fig. 2

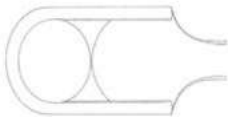
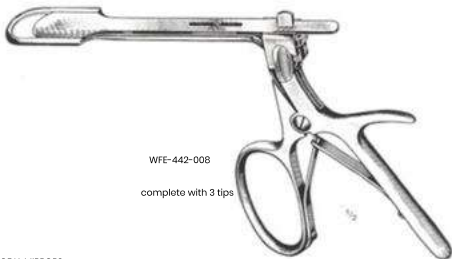

Fig. 3



WFE-442-008

complete with 3 tips

LARYNGEAL MIRRORS



- | | | | | |
|--------------------|---------------|---|----------------|--------------------|
| WFE-442-009 | Fig. 00 | = | 8 mm Ø | WFE-442-021 |
| WFE-442-010 | Fig. 0 | = | 10 mm Ø | WFE-442-022 |
| WFE-442-011 | Fig. 1 | = | 12mm Ø | WFE-442-023 |
| WFE-442-012 | Fig. 2 | = | 14mm Ø | WFE-442-024 |
| WFE-442-013 | Fig. 3 | = | 16mm Ø | WFE-442-025 |
| WFE-442-014 | Fig. 4 | = | 18 mm Ø | WFE-442-026 |
| WFE-442-015 | Fig. 5 | = | 20 mm Ø | WFE-442-027 |
| WFE-442-018 | Fig. 6 | = | 22mm Ø | WFE-442-028 |
| WFE-442-017 | Fig. 7 | = | 24 mm Ø | WFE-442-029 |
| WFE-442-018 | Fig. 8 | = | 26 mm Ø | WFE-442-030 |
| WFE-442-019 | Fig. 9 | = | 28 mm Ø | WFE-442-031 |
| WFE-442-020 | Fig. 10 | = | 30mm Ø | WFE-442-031 |



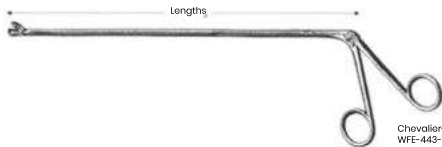

Chevallier-Jackson
 WFE-443-003-WFE-443-028

Upper Jaws Moveable

cm	in							
30	12	WFE-443-001	WFE-443-005	WFE-443-009	WFE-443-013	WFE-443-017	WFE-443-021	WFE-443-025
40	16	WFE-443-002	WFE-443-006	WFE-443-010	WFE-443-014	WFE-443-018	WFE-443-022	WFE-443-026
50	20	WFE-443-003	WFE-443-007	WFE-443-011	WFE-443-015	WFE-443-019	WFE-443-023	WFE-443-027
60	24	WFE-443-004	WFE-443-008	WFE-443-012	WFE-443-016	WFE-443-020	WFE-443-024	WFE-443-028



Huber
 WFE-443-029



Bruenings
 WFE-443-030

Universal Detachable Handles
 or use with interchangeable tips and tubes



WFE-443-031-WI-443-033

Straight	Lengths	
	cm	in*
WFE-443-031	20	8
WFE-443-032	30	12
WFE-443-033	40	16



Bruenings
 WFE-443-034
 20.0 cm / 8"

*Laryngeal Tube for above mentioned handle





Fraenkel
WFE-444-001



Seiffert
WFE-444-002



Fraenkel
WFE-444-003



Scheinmann
WFE-444-004



Scheinmann
WFE-444-005



WFE-444-006
WFE-444-007

Bruenings
WFE-444-008-WFE-444-007

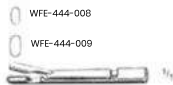

WFE-444-008
WFE-444-009

Bruenings
WFE-444-008-WFE-444-009



Lange
WFE-444-010



WFE-444-011
WFE-444-012

Krause
WFE-444-011-WFE-444-012



Krause
WFE-444-013

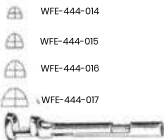

WFE-444-014
WFE-444-015
WFE-444-016
WFE-444-017
Cordes
WFE-444-014-WFE-444-017



with drawing cut
Schumacher
WFE-444-018



WFE-444-019
WFE-444-020

Cordes
WFE-444-019-WFE-444-020



Cordes
WFE-444-021



Rosenberg
WFE-444-022



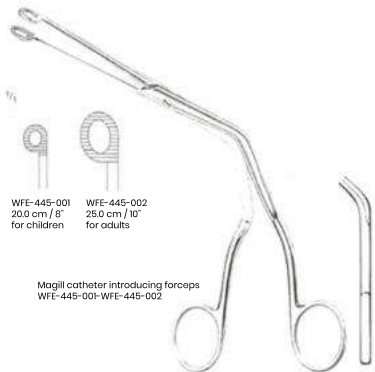

Miller
WFE-445-003

* Consisting of Battery Handle (without battery)
& 4 blades

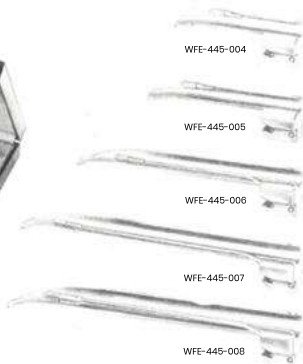



McIntosh
WFE-446-009

Laryngoscope set
consisting of
battery handle (without battery)
& three blades



WFE-446-010



WFE-446-011



WFE-446-012



WFE-446-013



WFE-446-014





Grabber Forceps
Long, fenestrated jaws
with interlocking wave-like
serrations for strong hold,
double action



WFE-448-011
ROTO-LOK, ratchet
5mm, 37cm

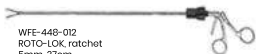

WFE-448-012
ROTO-LOK, ratchet
5mm, 37cm



Fundus Grabber Forceps
Long, beveled-edge jaws
permit a large purchase
on tissue and maintain
a strong hold



WFE-448-013
ROTO-LOK, ratchet
5mm, 37cm

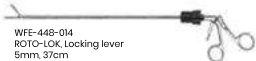

WFE-448-014
ROTO-LOK, Locking lever
5mm, 37cm

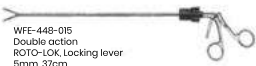

WFE-448-015
Double action
ROTO-LOK, Locking lever
5mm, 37cm



WFE-448-016
Double action
ROTO-LOK, Ratchet
5mm, 37cm

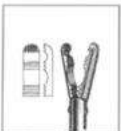

Dual-Cup Grasping Forceps
Double cup design
increases surface area
contact which improves
hold on tissue, double action



WFE-448-017
ROTO-LOK, Ratchet
5mm, 32cm

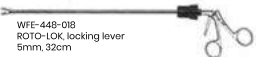

WFE-448-018
ROTO-LOK, locking lever
5mm, 32cm





Retraction Grasping Forceps
Long-rigid jaws with
2 x 3 blunt interdigitating
teeth for strong grasp
of heavy tissue



Atrau-Allis Grasping Forceps
Unique jaw design offers strong
atraumatic grasp,
double action

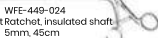
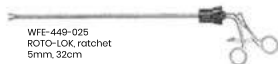

Atrau-Allis L.J Grasping Forceps
Unique jaw design, in
20 mm length offers
strong atraumatic grasp,
double action.

WFE-449-027
ROTO-LOK, ratchet
5mm, 37cm

WFE-449-028
ROTO-LOK, locking lever
5mm, 37cm





Allis Grasping Forceps
interlocking distal teeth with
fine-serrated inner jaws,
double action



WFE-450-029
Ratchet, insulated shaft
5mm, 32cm



WFE-450-030
ROTO-LOK Ratchet
5mm, 32cm



Retrograde Grasping Forceps
retrograde deep-serrated
teeth allow for non-slip hold
double action



WFE-450-031
Ratchet
5mm, 32cm



Grasping & dissecting Forceps
Cup-shaped, toothed jaws
double action



WFE-450-032
Monopolar
5mm, 32cm



Grasping & extracting Forceps
Retrograde
deep-serrated teeth



WFE-450-033
Spring-loaded
10mm, 32cm





Claw Forceps
2x3 interlocking teeth
for penetrating hold and
extraction of tissue



WFE-45I-034
Spring-loaded,
10mm, 32cm



Claw Forceps
2x3 interlocking teeth
for penetrating hold and
extraction of tissue



WFE-45I-035
Spring-loaded,
5mm, 32cm



DeBakey Forceps
Fenestrated 45mm long jaws
with DeBakey-type teeth,
double action.



WFE-45I-036
Ratchet,
5mm, 32cm



DeBakey Forceps, curved
Fenestrated 55mm long jaws
with DeBakey-type teeth,
double action.



WFE-45I-037
ROTO-LOK, ratchet,
10mm, 37cm



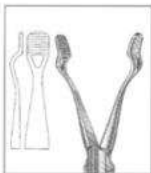

Paddle Babcock Forceps
Flat paddles with fine, straight serrations for atraumatic hold of delicate tissue, double action.



WFE-452-038
ROTO-LOK, ratchet,
10mm, 37cm



Paddle Babcock Forceps
Flat paddles with fine, straight serrations for atraumatic hold of delicate tissue, double action.



WFE-452-039
ROTO-LOK, ratchet,
5mm, 37cm

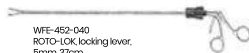

WFE-452-040
ROTO-LOK, locking lever,
5mm, 37cm



**Babcock Forceps
Traditional Style**
Babcock jaws designed with six rows of fine serrations for atraumatic, yet secure grasp of bowel and other delicate tissue, double action.



WFE-452-041
ROTO-LOK, ratchet,
10mm, 37cm



Babcock Forceps
Rounded jaws with 2 x 3 rows of De-Bakey-type teeth for atraumatic, yet secure grasp of bowel and other delicate tissue, double action.



WFE-452-042
Ratchet,
10mm, 32cm



WFE-452-043
ROTO-LOK, ratchet,
10mm, 32cm



Endoscopic Instruments Grasping Forceps



Babcock Forceps
Traditional design for grasping delicate tissue, double action.

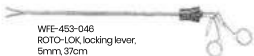

Swanstrom Grasping Forceps
Unique design of 1 x 2 De-Bakey-type teeth with triangular fenestration provides an effective hold with atraumatic grasp, double action.

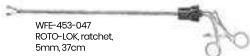

Duval Grasping Forceps
Triangular jaws with deep-serrated surfaces for non-slip, firm grasp of tissue, double action.



Endoscopic Instruments Grasping Forceps



Russian Grasping Forceps
40mm long jaws with heavy serrations for effective tissue grasp, double action.



WFE-454-051
Ratchet
10mm, 32cm



Foerster Sponge Forceps
45mm jaws firmly hold tissue, double action.



Hunter's Clamp
Right-angle shaft with Atraum-Ailis teeth for secure grasp and manipulation of tissue around structures, e.g. stomach esophagus in fundoplication, double action.



WFE-454-053
Ratchet
5mm, 32cm



Hunter's Bowel Grasper
Foreextended, 20mm jaws for atraumatic manipulation of delicate tissue, e.g. bowel, stomach, double action.



WFE-454-054
ROTO-LOCK
5mm, 32cm





Stone Extractor
To facilitate stone removal once neck of gallbladder has been externalized.

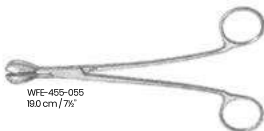

WFE-455-055
18.0 cm / 7 1/8"



Strong Forceps
Fenestrated, serrated, oval-shaped jaws that converge at distal end to prevent slippage, double action.



WFE-455-056 WFE-455-057
Monopolar Monopolar
5mm, 32 cm 5mm, 45 cm



Strong Atraumatic Grasping Forceps
Fenestrated, serrated, curved jaws with split-steel construction, for fixation of ovary or manipulation of pelvic tissues.



WFE-455-058 WFE-455-059
Spring handle Spring handle
5mm, 32cm 5mm, 45cm



Micro Dessecting Forceps
Delicate, fenestrated, serrated jaws for gentle blunt dissection, double action.

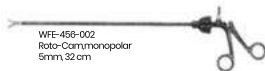

Needle, Nose Forceps
Slender, tapered and fine-serrated jaws



Tapered Dessecting Forceps
Tips of serrated, tapered jaws meet at fine point to allow delicate, yet firm grasp and dissection of thin adventitial tissue, double action.



Micro Grasping Forceps
3mm small, tapered areas for dissection of small structures.





Bullet-Nose Dissecting Forceps
Bullet-shaped, tapered
serrated jaws for dissection,
double action.



WFE-457-007
ROTO-CAM, monopolar
5mm, 32 mm



Tapered Maryland Dissector
Curved, finely-tapered,
serrated jaws with
wide spread, double action



WFE-457-008
ROTO-CAM, monopolar
5mm, 32 mm



Maryland Dissectors
Curved, tapered, serrated
jaws with wide spread,
double action



WFE-457-009
Monopolar
5mm, 32 mm

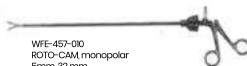

WFE-457-010
ROTO-CAM, monopolar
5mm, 32 mm



Maryland Dissectors
Slender, full-curved, long
serrated jaws with wide
spread, double action



WFE-457-011
ROTO-CAM, monopolar
10mm, 32 mm



Endoscopic Instruments Dessecting Forceps and Hooks



Mixer Dessecting Forceps
Slender, full-curved, long,
serrated jaws; with wide
spread, double action



WFE-458-012
10 mm, 32 cm



Mixer Spreader-Dissectors
Jaw design offers a true right-angle
for dissection around delicate
structures; double action.
The distinctive ergonomic handle
minimizes hand fatigue while
allowing the surgeon fine control
for precise dissection.



WFE-458-013
ROTO-CAM, monopolar
10 mm, 28 cm



WFE-458-014
ROTO-CAM, monopolar
right-handle, 10 mm, 32 cm



WFE-458-015
10 mm, 28 cm



Mixer Spreader-Dissectors
Jaw design offers a true right-angle
for dissection around delicate
structures; double action.
The distinctive ergonomic handle
minimizes hand fatigue while
allowing the surgeon fine control
for precise dissection.



WFE-458-016
ROTO-CAM, monopolar
5 mm, 28 cm



WFE-458-017
ROTO-CAM, monopolar,
ring-handle, 5 mm, 32 cm



Apple® Dissecting Hook
Right-angle tip allows rapid
blunt dissection and isolation
of structures.



WFE-458-018
10 mm, 40 cm





Supercut Scissors
Razor-sharp upper blade with finely-serrated lower blade allows clean, precise cut without tissue slippage

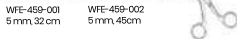

Supercyt Endo Scissors
Electrosurgical instrument with curved, SUPERCUT blades and precise cutting action offers mechanical cutting, electrosurgical cutting, blunt dissection, electrosurgical coagulation - all in one reusable, cost-effective instrument; double action



Hook Scissors
Blades designed to lift, isolate and transect tissue



Micro Scissors
Fine, delicate, 3 mm blades for small incision

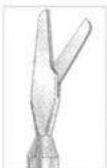
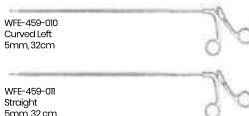

Mayo Operating Scissors
Large, sturdy blades for incising heavy tissue



Endoscopic Instruments Detach Scissors System



DETACH Scissors Insert

WF-460-001
Cleaning brushes, pkg 6

DETACH Handle/Shaft

WFE-460-002
ROTO-CAM, monopolar
5m, 32 cm



Supercut Detach Scissors
Unique Supercut blade has a finely-serrated lower blade that helps prevent tissue slippage, curved blades meet the contour of structures while the blunt shaped distal tip allows **tissue manipulation and cauterization** with blades closed, double action



WFE-460-003
ROTO-CAM, monopolar
5mm, 32 cm

WFE-460-004
Insert, 5 m, 32 cm

WFE-460-005
Insert, 5mm, 32cm, pkg 3



Hook Detach Scissors
Classic hook blades designed to lift, isolate and transect tissue



WFE-460-006
ROTO-CAM, monopolar
5mm, 32 cm

WFE-460-007
Insert, 5 m, 32 cm

WFE-460-008
Insert, 5mm, 32cm, pkg 3



Micro Detach Scissors
Curved,
Delicate, sharp-sharp
curved blades



WFE-460-009
ROTO-CAM, monopolar
5mm, 32 cm

WFE-460-010
Insert, 5 m, 32 cm

WFE-460-011
Insert, 5mm, 32cm, pkg 3



Endoscopic Instruments Detach Scissors System



Micro Detach Scissors
Straight
Delicate, sharp-sharp
straight blades

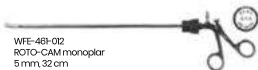

WFE-46I-012
ROTO-CAM monopolar
5 mm, 32 cm

WFE-46I-013
Insert, 5mm, 32cm

WFE-46I-014
Insert, 5mm, 32cm, pkg 3



Metzenbaum detach Scissors
Long, curved, tapered
blades with wide spread
double action

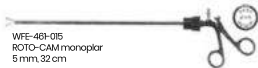

WFE-46I-015
ROTO-CAM monopolar
5 mm, 32 cm

WFE-46I-016
Insert, 5mm, 32cm

WFE-46I-017
Insert, 5mm, 32cm, pkg 3



"Baby" Metzenbaum Detach Scissors
Shorter, curved, very tapered
blades reach more narrow
and delicate dissection
areas, double action



WFE-46I-018
ROTO-CAM monopolar
5 mm, 32 cm

WFE-46I-019
Insert, 5mm, 32cm

WFE-46I-020
Insert, 5mm, 32cm, pkg 3



Mini detach Scissors
Curved, tapered, delicate
blades, double action

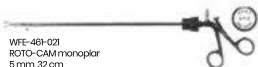

WFE-46I-021
ROTO-CAM monopolar
5 mm, 32 cm

WFE-46I-022
Insert, 5mm, 32cm

WFE-46I-023
Insert, 5mm, 32cm, pkg 3





Biopsy Forceps
two sharp teeth, one
on each jaw, for biopsy
or secure hold of
thick-walled tissue



WFE-462-001 1x1 teeth, Spring-loaded, 5mm, 32 cm	WFE-462-002 1x1 teeth, Spring-loaded 5mm, 45cm
---	---



Biopsy Punches
Serrated lower jaw



WFE-462-003 Monopolar 5mm, 32 cm	WFE-462-004 Monopolar 5mm, 45 cm
--	--



Hook Biopsy Punches
frangerheim-type
electrosurgical biopsy
punch with hook blade



WFE-462-005 Monopolar 5mm, 32 cm	WFE-462-006 Monopolar 5mm, 45 cm
--	--



Biopsy Punches
Single tooth in
upper jaw



WFE-462-007 Monopolar 5mm, 32 cm	WFE-462-008 Monopolar 5mm, 45 cm
--	--



Biopsy Forceps
Oval-shaped
fenestrated jaws.



WFE-462-009 Monopolar 5mm, 32 cm	WFE-462-010 Monopolar 5mm, 45 cm
--	--



Micro Biopsy Forceps
3mm jaws for biopsy of
small, delicate tissues

WFE-463-001
Spring-loaded
5mm, 32 cm



Spoon Forceps
Wide cup-shaped jaws for
tissue or stone removal

WFE-463-002
Spring-loaded
10mm, 32cm



Cholangiogram Clamp
Channel for placement of
5 Fr. or smaller cholangiogram
catheter

WFE-463-003
Ratchet
5mm, 32cm



Cholangiogram Guide
Curved tip for simple
placement of cholangiogram
catheter

WFE-463-004
5mm, 32cm



Bassler/Treat[®] Suture Forceps
Uniquely designed jaws
allow easier grasp and
positioning of tubular
structure for placement
of purse string with straight
of curved needle

WFE-463-005
10mm, 32 cm





Microsurgical Forceps
with platform, round handle, 18.0 cm / 7"

- WFE-464-001 - Curved 0.4mm micro tip
- WFE-464-002 - Curved 0.5mm micro tip 1/2 teeth
- WFE-464-003 - Curved 0.8mm delicate tip
- WFE-464-004 - Curved 0.8 delicate 1x2
- WFE-464-005 - Straight 0.4 mm micro tip
- WFE-464-006 - Straight 0.5mm micro tip 1x2 teeth
- WFE-464-007 - Straight 0.5mm micro tip 1x2 teeth
- WFE-464-008 - Straight, 0.8mm delicate tip 1x2 teeth



Rhoton Type Suture Tying forceps
with platform, round handle,
18.0 cm / 7" Straight
WFE-464-009



Micro Suture Tying Forceps
With platform round handle
15.0cm / 6"

- WFE-464-010 Curved
- WFE-464-011 Straight



WFE-465-001 WFE-465-003
Serrated

WFE-465-002 WFE-465-004
Serrated

Microsurgical Scissors
wide handle, 15.0 cm / 6"
regular blade
WFE-465-001 - WFE-465-004



WFE-465-005

WFE-465-006

Microsurgical Scissors
wide handle, 5.0 cm / 6"
Micro blade
WFE-465-005 - WFE-465-006



WFE-465-007

WFE-465-008

Microsurgical Scissors
Round handle, 18.0 cm / 7"
regular blade
WFE-465-007 - WFE-465-009

WFE-465-009
Angled to side, 60°



WFE-465-010

WFE-465-011

Microsurgical Scissors
Round handle, bayonet
shape, 21.0 cm, 8 1/4"
regular blade
WFE-465-010 - WFE-465-011





Microsurgical Needle Holders
round handle, 15.0 cm / 6"
WFE-466-001 - WFE-466-004

- WFE-466-001 Straight jaw
- WFE-466-002 Curved jaw
- WFE-466-003 Straight jaw, catch
- WFE-466-004 Curved jaw, catch



Microsurgical Needle Holders
wide handle, 15.0 cm / 6"
WFE-466-005 - WFE-466-006

- WFE-466-005 Straight jaw
- WFE-466-006 Curved jaw



Microsurgical Needle Holders
round handle, 18.0 cm / 7"
WFE-466-007 - WFE-466-014

- WFE-466-007 Straight jaw, micro tip
- WFE-466-008 Straight jaw, micro tip, catch
- WFE-466-009 Straight jaw, delicate tip
- WFE-466-010 Straight jaw, delicate tip, catch
- WFE-466-011 Curved jaw, micro tip
- WFE-466-012 Curved jaw, micro tip, catch
- WFE-466-013 Curved jaw, delicate tip
- WFE-466-014 Curved jaw, delicate tip, catch



Micro Surgery Scissors, Needle Holders and Forceps



Yasargil Scissors
bayonet handle, 22.0cm / 8 3/4"
WFE-467-001 - WFE-467-004

WFE-467-001 Straight, regular blade
WFE-467-002 Curved, regular blade
WFE-467-003 Straight, micro blade
WFE-467-004 Curved, micro blade



Yasargil Needle Holders
bayonet handle, 22.0cm / 8 3/4"
WFE-467-005 - WFE-467-006

WFE-467-005 Straight, regular
WFE-467-006 Curved, regular



Yasargil Forceps
bayonet handle, 22.0cm / 8 3/4"
WFE-467-007 - WFE-467-008

WFE-467-007 Blunt tip
WFE-467-008 Sharp tip



Micro Surgery Scissors, Needle Holders



Jacobson Scissors,
straight handle, 18.5 cm / 7 1/4"
WFE-468-001 - WFE-468-003

WFE-468-001 Straight blade
WFE-468-002 Curved blade
WFE-468-003 Angled on edge



Jacobson Needle Holders,
straight handle, 18.0 cm / 7"
WFE-468-009 - WFE-468-010

WFE-468-009 Without catch
WFE-468-010 With catch



Jacobson Needle Holders,
straight handle, without catch
18.0 cm / 7"
WFE-468-011 - WFE-468-012

WFE-468-011 Straight jaw
WFE-468-012 Fine curved jaw

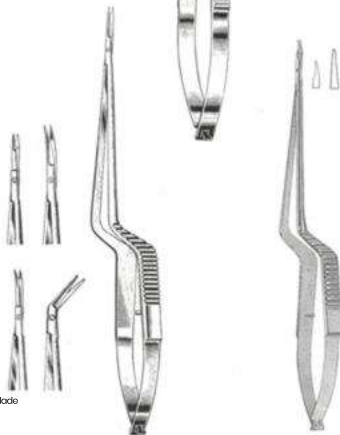

Jacobson Scissors,
straight handle, 18.5 cm / 7 1/4"
WJ-468-004 - WJ-468-008

WJ-468-004 Straight, regular blade
WJ-468-005 Curved, regular blade
WJ-468-006 Angled on edge, regular blade
WJ-468-007 Straight, micro blade
WJ-468-008 Curved, micro blade

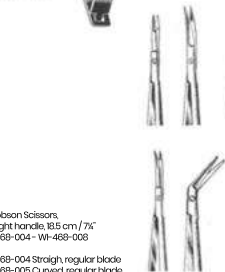

Micro Surgery Needle Holders and Forceps



Microsurgical Needle Holders
18.0 cm / 7" Carb-Bite jaws

WFE-469-001 Smooth
WFE-469-002 Serrated



Microsurgical Needle Holders
21.5 cm / 8 1/2" Carb-Bite jaws

WFE-469-003 Smooth
WFE-469-004 Serrated

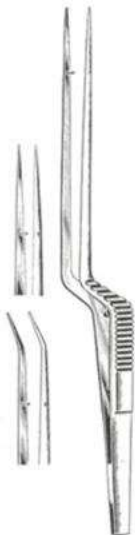

Jacobson Forceps
bayonet handle, 18.0 cm / 6 1/2"
sharp tips
WFE-469-005



Jacobson Forceps
bayonet handle, 18.5 cm / 7 1/2"

WFE-469-006 - Blunt tips
WFE-469-007 - Sharp tips
WFE-469-008 - Angled blunt tips





Eye Dressing Forceps
10.0 cm / 4" delicate
serrated, straight,
0.7mm wide at tip
WFE-470-001

Eye Dressing Forceps
10.0 cm / 4"
serrated, straight,
0.8mm wide at tip
WFE-470-002



Eye Dressing Forceps
9.9 cm / 3⁹/₁₆" delicate
serrated, half curved,
0.7mm wide at tip
WFE-470-003

Eye Dressing Forceps
9.9 cm / 3⁹/₁₆"
serrated, half curved
0.8mm wide at tip
WFE-470-004



Eye Dressing Forceps
9.7 cm / 3¹⁵/₁₆" delicate
serrated, full curved,
0.7mm wide at tip
WFE-470-005

Eye Dressing Forceps
9.7 cm / 3¹⁵/₁₆" delicate
serrated, full curved,
0.7mm wide at tip
WFE-470-006



Iris Forceps
10.0 cm / 4" delicate
straight, b2 tooth
0.7mm wide at tip
WFE-470-007

Iris Forceps
10.0 cm / 4" delicate
straight, b2 tooth
0.8mm wide at tip
WFE-470-008



Iris Forceps
9.9 cm / 3⁹/₁₆" delicate
half curved, b2 tooth
0.7mm wide at tip
WFE-470-009

Iris Forceps
9.9 cm / 3⁹/₁₆" delicate
half curved, b2 tooth
0.8mm wide at tip
WFE-470-010



Iris Forceps
9.7 cm / 3¹⁵/₁₆" delicate
full curved, b2 tooth
0.7mm wide at tip
WFE-470-011

Iris Forceps
9.7 cm / 3¹⁵/₁₆" delicate
full curved, b2 tooth
0.8mm wide at tip
WFE-470-012





Von Graefe Iris Forceps
7.2cm / 2¾", straight 0.7mm tip

WFE-473-013 Serrated
WFE-471-014 1x2 teeth



Von Graefe Iris Forceps
7.2cm / 2¾", curved, 0.7mm tip

WFE-473-015 Serrated
WFE-471-016 1x2 teeth



Gill Iris Forceps
7.5 cm / 3", curved, 0.5mm tip
1x2 teeth
WFE-471-017



Bishop Harmon Iris Forceps
8.9 cm / 3½"

WFE-471-018 - 0.6mm, 1 x 2 teeth
WFE-471-019 - 0.4mm, 1 x 2 teeth, extra delicate
WFE-471-020 - 0.3mm, 1 x 2 teeth micro surgery
WFE-471-021 - 0.6mm, serrated



Gill Iris Forceps
7.5 cm / 3", curved, 0.6mm tip
1 x 2 teeth down
WFE-471-022



Gill Iris Forceps
7.5 cm / 3", curved
cross-serrated
WFE-471-023



Botvin Iris Forceps
7.5 cm / 3", bayonet-shaped
cross-serrated
WFE-471-024





Elsching Fixation Forceps
10.6 cm/ 4 1/8"
1 x 2 teeth
WFE-472-001



Thorpe Conjunctival
Fixation Forceps
9.5 cm/ 4 1/8"
2 x 3 teeth with tying platform
WFE-472-002



Von Graefe Fixation Forceps
11.4 cm/ 4 1/2"
with catch, 4.5mm jaws
WFE-472-003



Von Graefe Fixation Forceps
11.4 cm/ 4 1/2"
plain, 4.5mm jaws
WFE-472-004



Lester Fixation Forceps
9.7 cm/ 3 7/8"
2 x 3 teeth
WFE-472-005



Lester Fixation Forceps
9.7 cm/ 3 7/8"
1 x 2 teeth
WFE-472-006

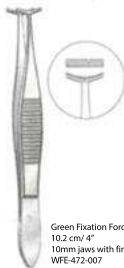

Green Fixation Forceps
10.2 cm/ 4"
10mm jaws with fine teeth
WFE-472-007



Bracken Fixation Forceps
10.8 cm/ 4 1/8"
1 x 2 teeth
WFE-472-008



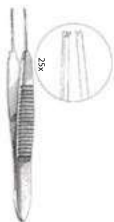

Bonn Iris Forceps
7.0 cm / 2 3/4"
0.12 mm teeth
original pattern,
without tying platform
WFE-473-001

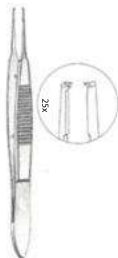

Bonn Suture Forceps
9.5 cm / 3 3/4"
0.12 mm teeth
5mm tying platform
WFE-473-002



Troutman-Barrager Utility Forceps (Colibri-Type)
7.5 cm / 2 7/8", teeth at 45° angle
6mm tying platform

WFE-473-003 - 0.12 mm teeth
WFE-473-004 - 0.3mm teeth
WFE-473-005 - 0.5 mm teeth

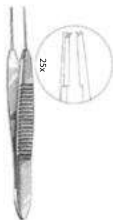

Bonn Iris Forceps
7.0 cm / 3 3/4"
0.12 mm teeth
4mm tying platform
WFE-473-006





Girard Corneo-Scleral Forceps
(Colibri-Type)
10.8 cm / 4 1/4", for right hand
round knurled handle,
0.12 mm teeth, 6mm tying platform
WFE-474-007



Girard Corneo-Scleral Forceps
(Colibri-Type)
10.8 cm / 4 1/4", for left hand
round knurled handle,
0.12 mm teeth, 6mm tying platform
WFE-474-008



Castroviejo Corneo-Scleral
Suture Forceps
4" (10.2cm), 6mm tying platform
WFE-474-009 - 0.5mm teeth
WFE-474-010 - 0.9mm teeth
WFE-474-011 - 1.5mm teeth



Castroviejo Colibri Forceps
10.8 cm / 4 1/4", wide handle,
0.5 mm teeth, 7mm tying platform
WFE-474-012



Castroviejo Suture Forceps
10.8 cm / 4 1/4", wide angle,
6mm tying platform
WFE-474-013 - 0.12mm teeth
WFE-474-014 - 0.3mm teeth
WFE-474-015 - 0.5mm teeth
WFE-474-016 - 0.9mm teeth
WFE-474-017 - 1.5mm teeth

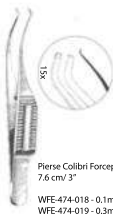

Pieler Colibri Forceps
7.6 cm / 3"
WFE-474-018 - 0.1mm teeth
WFE-474-019 - 0.3mm teeth



Castroviejo Fixation Forceps
10.8 cm / 4 1/4", wide handle,
without tying platform
WFE-474-020 - 0.3 mm teeth
WFE-474-021 - 0.5mm teeth



Jewelers Style Forceps
Style 1: very fine
WFE-475-001



Jewelers Style Forceps
Style 3: very fine
WFE-475-002



Jewelers Style Forceps
Style 3C: very fine
WFE-475-003



Jewelers Style Forceps
Style 4: very fine
WFE-475-004



Jewelers Style Forceps
Style 5: very fine
WFE-475-005



Jewelers Style Forceps
Style 7: very fine, curved
WFE-475-006



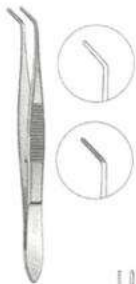

Nugent Utility Forceps
10.8 cm / 4", 45° angled jaws
WFE-476-001- Smooth
WFE-476-002- Cross-serrated



Wills Hospital Utility Forceps
10.2 cm / 4", cross rated
WFE-476-003



McCullough Utility Forceps
10.2 cm / 4", cross-serrated
WFE-476-004



McCullough Utility Forceps
10.2 cm / 4", cross-serrated
1 x 2 teeth
WFE-476-005



Harms Suture Tying Forceps
10.8 cm / 4", Wide handle
6.5m tying platform

WFE-476-006-Straight
WFE-476-006-Curved



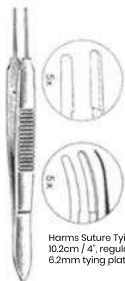

Harms Suture Tying Forceps
10.2cm / 4", regular handle,
6.2mm tying platform

WFE-477-008 - Straight
WFE-477-009 - Curved



Castroviejo Suture Tying Forceps
10.8cm / 4 1/4", 5mm tying platform
WFE-477-010



Troutman-Barraquer Corneal
Utility Forceps (Collibri-Type)
7.1cm / 2 3/4", 0.12mm teeth
WFE-477-011

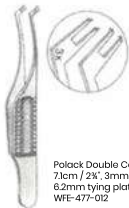

Polack Double Corneal Forceps (Collibri-Type)
7.1cm / 2 3/4", 3mm long tips with 1 x 2 teeth
6.2mm tying platform
WFE-477-012

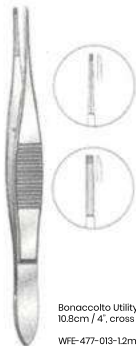

Bonaccolto Utility Forceps
10.8cm / 4", cross serrated

WFE-477-013-12mm wide platform
WFE-477-014-17mm wide platform





Chandler Iris Forceps
11.4 cm / 4 1/2 inch
1.5 mm / 1/16 inch
WFE-478-016

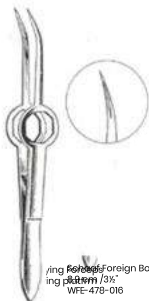

Ring Forceps
11.4 cm / 4 1/2 inch
WFE-478-016



Prattman-Ba
Utility Forceps
7.1 cm / 2 3/4 inch

Strong Utility Forceps
cross-serrated

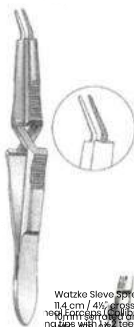

Watzke Sleeve Spreading Forceps
11.4 cm / 4 1/2 inch cross-act
1.5 mm / 1/16 inch teeth
WFE-478-016



Sauer Suture Forceps
8.8 cm / 3 1/2 inch
1.5 mm / 1/16 inch teeth
cross-serrated

477-013-12mm side plot
477-014-17mm





McPherson Suture Tying Forceps
8.9 cm / 3 1/2", straight
4.5mm tying platform
WFE-479-019



McPherson Suture Tying Forceps
8.9 cm / 3 1/2", angled
4.5mm tying platform
WFE-479-020



McPherson Micro Corneal Forceps
8.9 cm / 3 1/2", straight, 1 x 2 teeth
4.5mm tying platform
WFE-479-021



McPherson Micro corneal Forceps
8.9 cm / 3 1/2", angled,
1 x 2 teeth, 7.45mm tying platform
WFE-479-022



Kalman-McPherson Suture Tying Forceps
8.6 cm / 3 3/4", angled,
7mm tying platform
WFE-479-023



Kalman-McPherson Micro Corneal Forceps
8.9 cm / 3 1/2", straight,
1 x 2 teeth, 7mm tying platform
WFE-479-024





Sheets-McPherson Tying Forceps
8.3cm / 3¼", 45°, angled jaws
1mm cross-serrated tips,
10.5mm tying platform
WFE-480-001

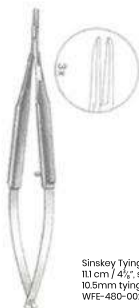

Sinsky Tying Forceps
11 cm / 4½", straight
10.5mm tying platform
WFE-480-002

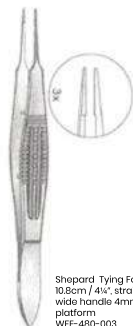

Shepard Tying Forceps
10.8cm / 4¼", straight
wide handle 4mm tying
platform
WFE-480-003

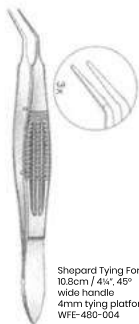

Shepard Tying Forceps
10.8cm / 4¼", 45°
wide handle
4mm tying platform
WFE-480-004

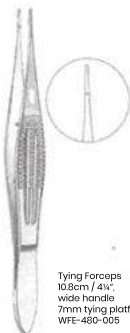

Tying Forceps
10.8cm / 4¼",
wide handle
7mm tying platform
WFE-480-005

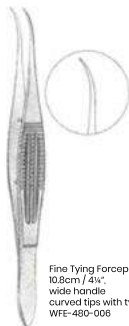

Fine Tying Forceps
10.8cm / 4¼",
wide handle
curved tips with tying surface
WFE-480-006



Ophthalmic Surgery Cilia Forceps and Lens Forceps



Ziegler Cilia Forceps
8.6cm / 3 1/4"
WFE-481-001



Littauer Cilia Forceps
8.3cm / 3 1/8"
WFE-481-002



Douglas Cilia Forceps
8.9cm / 3 1/2"
WFE-481-003



Gracie Cilia Forceps
9.8cm / 3 7/8"
2mm wide platform
WFE-481-004



Barraquer Cilia Forceps
10.2 cm / 4"
6mm long platform
WFE-481-005



Shepard Intraocular
Lens Forceps
9.2 cm / 3 5/8", curved shafts
slide lock
15mm upper and
2mm lower serrated jaws
WFE-481-006



Clayman Lens Forceps
12.0 cm / 4 3/4", curved shafts
3mm angled tips
WFE-481-007



Thornton Intractor
Lens Forceps
8.6 cm / 3 3/8"
11mm angled jaws 45°
WFE-481-008



Ophthalmic Surgery

Chalazion Forceps



Lambert Chalazion Forceps
9.2cm / 3 $\frac{3}{4}$ "
8mm inside diameter
of fenestrated jaw
WFE-482-001



Health Chalazion Forceps
9.5cm / 3 $\frac{1}{4}$ "
12mm x 14mm inside diameter
of fenestrated jaw
WFE-482-002



Hunt Chalazion Forceps
9.5cm / 3 $\frac{1}{4}$ "
12mm inside diameter
of fenestrated jaw
WFE-482-003



Desmarres Chalazion Forceps
8.9cm / 3 $\frac{1}{2}$ "

WFE-482-004 11mm x 17mm inside
diameter of
fenestrated jaw

WFE-482-005 11.5mm x 22.5mm
inside
diameter of
fenestrated jaw

WFE-482-006 16.5mm x 28mm
inside
diameter of
fenestrated jaw



Lordan Chalazion Forceps
9.5cm / 3 $\frac{3}{4}$ "
7.5 x 12mm inside dimensions
of fenestrated jaw
WFE-482-007



Francis Chalazion Forceps
9.5cm / 3 $\frac{3}{4}$ "
12 x 14mm inside diameter
of fenestrated jaw

WFE-482-008



Snellen Entropion Forceps
8.5cm / 3 $\frac{1}{2}$ "
35mm
wide solid plate

WFE-482-009 Left
WFE-482-010 right (illustrated)



Ophthalmic Surgery Capsule and Muscle Forceps



Arruga Capsule Forceps
10.2cm / 4"
WFE-483-001



Castroviejo Capsule Forceps
10.2cm / 4", cross action
WFE-483-002

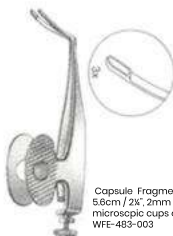

Capsule Fragment and Clot Forceps
5.6cm / 2 1/4", 2mm platform and
microscopic cups on inner jaw surface
WFE-483-003



Berke Ptsis Clamp
10.2 cm/ 4", 20mm jaws
WFE-483-004



Jameson Muscle Recession Forceps
10.2 cm/ 4"

- WFE-483-005 Left, 12mm jaws
- WFE-483-006 Left, 7mm jaws
- WFE-483-007 right, 12mm jaws
- WFE-483-008 right, 7mm jaws



Troutman superior Rectus Forceps
10.5 cm/ 4 1/4",
45° angle 10mm from tip to bend
WFE-483-009 Left, 12mm jaws





Kalt Needle Holder
13.3cm / 5¼", 12mm jaws, straight
serrated thumb plate with lock
WFE-484-001



Kalt Needle Holder
13.3cm / 5¼", 10mm jaws,
smooth thumb plate with lock
WFE-484-002 Straight
WFE-484-003 Curved right
WFE-484-004 Curved left



Castroviejo Needle Holder
14.0 cm / 5½", 11mm smooth jaws,
flat serrated plate with lock
WFE-484-005 Curved
WFE-484-006 Straight



Castroviejo Needle Holder
14.0 cm / 5½", 10mm smooth jaws,
flat serrated plate with lock
WFE-484-007 straight,
WFE-484-008 Curved,



Castroviejo Needle Holder
13.0 cm / 5", 9mm smooth jaws,
wide serrated plate with lock
WFE-484-009 straight, without lock
WFE-484-010 Curved, without lock
WFE-484-011 straight with lock
WFE-484-012 Curved, with lock



Castroviejo Needle Holder
14.0 cm / 5½", 11mm smooth jaws,
flat serrated plate with lock
WFE-484-013 Smooth
WFE-484-014 Serrated





Barraquer Needle Holders
13.3cm 5 $\frac{1}{4}$ " 9mm curved jaws
round knurled handle

WFE-485-015 With lock
WFE-485-016 Without lock



Barraquer Needle Holders
10.2cm 5" 10mm smooth jaws
round knurled handle

WFE-485-017 Staright, Without lock
WFE-485-018 Staright With lock
WFE-485-019 Curved Without lock
WFE-485-020 Curved With lock



McPherson Needle Holders
10.2cm 4" 10mm smooth jaws
flat serrated handle

WFE-485-021 Staright, Without lock
WFE-485-022 Staright With lock
WFE-485-023 Curved Without lock
WFE-485-024 Curved With lock



Anis Needle Holders
13.0 cm 5", 8mm smooth jaws
round knurled handle without lock

WFE-485-025 Straight
WFE-485-026 Curved



Anis Needle Holders
13.0 cm 5", 8mm smooth jaws
round knurled handle with lock

WFE-485-027 Straight
WFE-485-028 Curved



Cohan Miniature
Needle Holders
10.4 cm 4 $\frac{1}{4}$ " 8mm smooth
curved jaws
round knurled handle

WFE-485-029 without lock
WFE-485-030 with lock



Troutman Needle Holders
11.7 cm 4 $\frac{1}{2}$ " 10mm smooth
curved jaws
round serrated handle

without lock
WFE-485-031





Knapp Iris Scissors
10.1cm / 4", 25mm blades

WFE-486-001 Straight,sharp-sharp
WFE-486-002 Curved, sharp-sharp

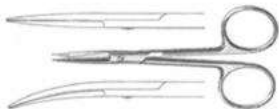

Knapp Iris Scissors
10.1cm / 4", 25mm blades

WFE-486-003 Straight,sharp-blunt
WFE-486-004 Curved, sharp-blunt

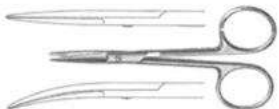

Knapp Iris Scissors
10.1cm / 4", 25mm blades

WFE-486-005 Straight,blunt-blunt
WFE-486-006 Curved, blunt-blunt

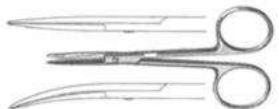

Iris Scissors
11.4cm / 4 1/2", 25mm blades

WFE-486-007 Straight,sharp-blunt
WFE-486-008 Curved, blunt-blunt

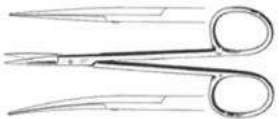

Iris Scissors
11.4cm / 4 1/2", Carb-edge
25mm blades

WFE-486-009 Straight,
WFE-486-010 Curved,

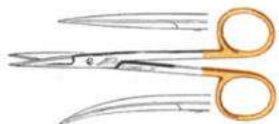



Supercut Iris Scissors
11.4cm / 4 1/2", 25m blades

WFE-487-011 Straight
WFE-487-012 Curved



Iris Scissors
11.4cm / 4 1/2", angled over edge
25m blades
WFE-487-013

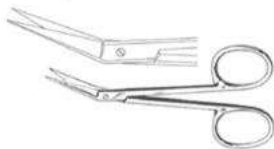

Iris Scissors
11.4cm / 4 1/2", angled over edge
25m blades, proe points
WFE-487-014



Iris Scissors
2mm blades

WFE-487-015 8.9cm / 3 1/2", straight
WFE-487-016 8.9cm / 3 1/2", curved
WFE-487-017 10.5cm / 4 1/4", delicate, straight
WFE-487-018 10.5cm / 4 1/4", delicate, curved





Wilmer Conjunctival Scissors
10.5cm, 4 $\frac{1}{2}$ " delicate, 15 mm blades
angled on flat
WFE-488-019



Iris Scissors
10.2cm, 4", 24mm blades
large finger rings

WFE-488-020 Straight
WFE-488-021 Curved

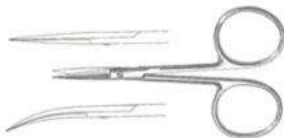

Iris Scissors
10.5cm, 4 $\frac{1}{4}$ ", delicate, 27mm blades

WFE-488-022 Straight
WFE-488-023 Curved

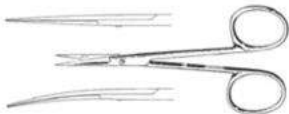

Iris Scissors
10.2cm, 4", 22mm blades
flat shanks

WFE-488-024 Straight
WFE-488-025 Curved

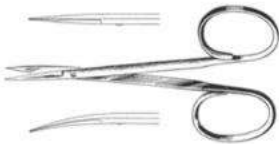

Iris Scissors
8.9cm, 3 $\frac{3}{8}$ " delicate, 22mm blades
flat shanks

WFE-488-026 Straight
WFE-488-027 Curved





Utility Scissors
10.5 cm / 4 $\frac{1}{4}$ " 15 mm blades
flat shanks

WFE-489-028 Straight
WFE-489-029 Curved



Strabismus Scissors
11.4cm / 4 $\frac{1}{2}$ ", 130mm blades

WFE-489-030 Straight
WFE-489-031 Curved

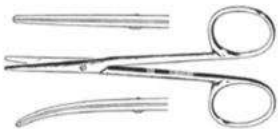

Strabismus Scissors
11.4cm / 4 $\frac{1}{2}$ ", 30mm blades, Carb-edge

WFE-489-033 Straight
WFE-489-033 Curved



Strabismus Scissors
10.5 cm / 4 $\frac{1}{4}$ ", 25mm blades
flat shanks

WFE-489-034 Straight
WFE-489-035 Curved

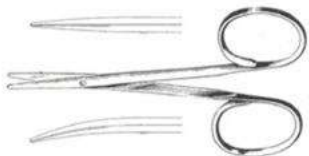

Ophthalmic Surgery

Eye Scissors



Stevens Tenotomy Scissors, blunt tips

WFE-490-001 11.4 cm / 4 1/2", straight, slender pattern, 13mm blades
WFE-490-002 11.4 cm / 4 1/2", curved, slender pattern, 13mm blades
WFE-490-002 11.4 cm / 4 1/2", straight, standard pattern, 12mm blades
WFE-490-002 11.4 cm / 4 1/2", straight, standard pattern, 12mm blades

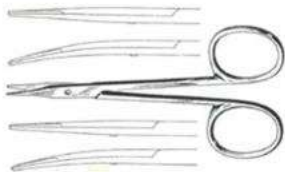

Stevens Tenotomy Scissors 9.5 cm / 3 3/4", 13mm blades blunt tips, flat shanks

WFE-490-005 Straight
WFE-490-006 Curved



Westcott Utility Scissors 13.0cm / 5 1/4", 23mm blades curved round sharp tips WFE-490-007



Westcott Tenotomy Scissors 11.4cm / 4 1/2", 18mm blades rond blunt tips

WFE-490-008 Right, curved
WFE-490-009 Left, curved
WFE-490-010 Straight

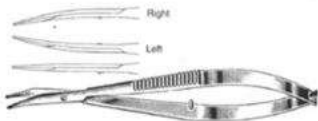

Ophthalmic Surgery Eye Scissors

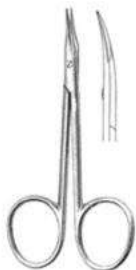

Stevens Stitch Scissors
10.5cm / 4 $\frac{1}{4}$ " 14mm blades
curved, sharp tips
WFE-491-011



Stevens Stitch Scissors
9.5cm / 4 $\frac{1}{4}$ " 12mm blades
curved, sharp tips, flat shanks
WFE-491-012



Westcotts Stitch Scissors
11.5cm / 4 $\frac{1}{2}$ " 18mm blades
curved, fine, sharp tips,
WFE-491-013

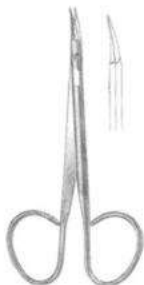

Stitch Scissors
12.4cm / 4 $\frac{1}{4}$ " 13mm blades
curved, fine, sharp tips, flat shanks
WFE-491-014



Enucleation Scissors
13.0cm / 5 $\frac{1}{4}$ " 32mm blades
strong curve
WFE-491-015

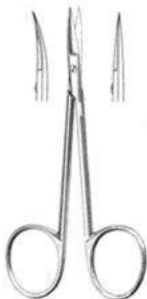

Stitch Scissors
9.8 cm / 3 $\frac{7}{8}$ " 15mm blades
semi-sharp tips
WFE-491-017 Straight



Gradle Stitch Scissors
9.5 cm / 3 $\frac{7}{8}$ " 13mm blades
blunt tips
WFE-491-019



O'Brien Suture Scissors
9.5 cm / 3 $\frac{7}{8}$ " 15mm blades
angled
WFE-491-020

Enucleation Scissors
13.0cm / 5" 27mm blades
light curve
WFE-491-016

WFE-491-018 Curved





Micro Stitch Scissors
10.2 cm / 4" 7mm blades
fine sharp tips

WFE-492-021 Straight
WFE-492-022 Curved



Micro Stitch Scissors
11.4 cm / 4 1/2" 16mm blades
sharp tips

WFE-492-023 Straight
WFE-492-024 Curved



McClure Iris Scissors
11.4 cm / 4 1/2" 14mm blades
angled on flat

WFE-492-025



Castroviejo Corneal Scissors
10.8 cm / 4 1/4" 12mm blades
curved, blunt tips

WFE-492-026



Castroviejo Iris Scissors
9.5cm / 3 3/4" 11m blades
curved, sharp tips

WFE-492-027



Castroviejo Corneal Scissors
10.8cm / 4 1/4" 12m blades
angled, blunt tips

WFE-492-028

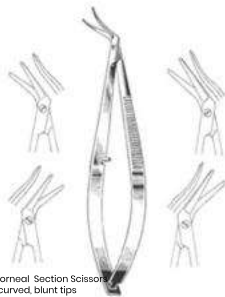

Castroviejo Corneal Section Scissors
10.8cm / 4 1/4" curved, blunt tips

WFE-492-029 Right, standard, 13mm blades
WFE-492-030 Left, standard, 13mm blades
WFE-492-031 Right, miniature, 11mm blades
WFE-492-032 Left, miniature, 11mm blades



Ophthalmic Surgery

Eye Scissors



Castroviejo Corneal Section Scissors
10.2 cm / 4" microsurgery 7mm blades
curved, blunt tips

WFE-493-033 right
WFE-493-034 left



Castroviejo Corneal Section Scissors
10.5 cm / 4 1/8" miniature 7mm blades
curved, blunt tips

WFE-493-035 Left
WFE-493-036 Right



Trautman-Castroviejo Corneal Section Scissors
10.5 cm / 4 1/8" miniature 7mm blades
curved, blunt tips

WFE-493-037 Left
WFE-493-038 Right



Vannas Capsulotomy Scissors
8.2cm / 3 1/8", sharp tips

WFE-493-039 Straight, 5mm blades
WFE-493-040 Curved, 5mm blades
WFE-493-041 Angled to side, 6mm blades
WFE-493-042 Angled on flat, 6mm blades

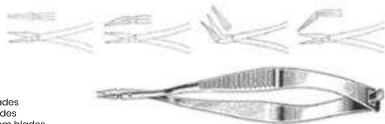

Ophthalmic Surgery

Eye Scissors



Katzin Corneal Transplant Scissors
10.8cm / 4 1/4", miniature 8mm blades
curved, blunt tips

WFE-494-043 left
WFE-494-044 right



McPherson-Vannas Iris Scissors
8.2cm / 3 1/4", 5mm blades
curved, sharp tips
WFE-494-045



Gills-Weish Vannas Scissors
angled, sharp tips

WFE-494-046 7.9cm / 3 1/8", microsurgery 5mm blades
WFE-494-047 8.6cm / 3 3/8", microsurgery 00mm blades



Barraquer-Dowecker Iris Scissors
5.7cm / 2 1/4", 7m blades,
angled on flat, blunt tips
WFE-494-048

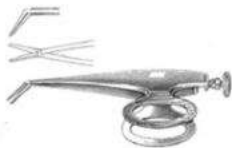



Castroveljo Caliper
8.2 cm / 3 1/8", straight, measures from
0mm to 20 mm in 1mm increments
WFE-495-001



Castroveljo Marking Caliper
8.2 cm / 3 1/8", straight, measures from
0mm to 20 mm in 1mm increments
with grooves for marking fluid
WFE-495-002



Thrope Caliper
121 cm / 4 3/4", measures from
0mm to 80 mm in 1mm increments
and 0 to 3 inches in 1/4" increments
WFE-495-003



Jameson Caliper
8.6 cm / 8 3/8", measures from
0mm to 80 mm in 1mm increments
and 0 to 3 inches in 1/4" increments
WFE-495-004





Steel Rule
graduated 15.0cm / 6"
WFE-496-001



Steel Rule
graduated 30.0cm / 12"
WFE-496-002



Bowman Lacrimal Probes
12.4cm / 4 7/8", double-ended, silver

WFE-496-003 Sizes 0000-000
WFE-496-004 Sizes 000-0
WFE-496-005 Sizes 1-2
WFE-496-006 Sizes 3-4
WFE-496-007 Sizes 5-6
WFE-496-008 Sizes 7-8



Williams Lacrimal Probes
12.4cm / 4 7/8", double-ended, silver

W-496-009 Sizes 0000-000
W-496-010 Sizes 000-0
W-496-011 Sizes 1-2
W-496-012 Sizes 3-4
W-496-013 Sizes 5-6
W-496-014 Sizes 7-8



Surgical Instruments Made Right :)

+92 92 52 459 8700 / +92 300 6102089

worthfieldent@gmail.com

www.wfent.biz



WORTH FIELD ENTERPRISES

Post Box# 998

Sialkot - 51310

PAKISTAN